



# **TV 3.0 Project - Phase 3 - Over-the-air Physical Layer Laboratory Tests**

---

06 November 2023

Brazilian Digital Terrestrial Television System Forum

Brazilian Ministry of Communications

Brazilian National Education and Research Network (RNP, *Rede Nacional de Ensino e Pesquisa*)

Mackenzie Presbyterian University (*Universidade Presbiteriana Mackenzie*)

## Table of Contents

<b>1</b>	<b>Introduction</b> .....	<b>5</b>
<b>2</b>	<b>Research Team</b> .....	<b>8</b>
<b>3</b>	<b>Glossary</b>	<b>9</b>
<b>4</b>	<b>TV 3.0 Architecture</b> .....	<b>12</b>
<b>5</b>	<b>TV 3.0 Phase 3 Testing and Evaluation</b> .....	<b>13</b>
5.1	<i>Device Verification Tests</i> .....	13
5.1.1	RF frequency accuracy (precision) .....	13
5.2	<i>Evaluation Tests</i> .....	13
5.2.1	C/N – Carrier power vs Noise Power in Rayleigh and AWGN Channels .....	13
5.2.2	Co-channel and Adjacent Channel Interference (at $N\pm 1$ and $N\pm 2$ channels) to ISDB-T .....	14
5.2.3	Adjacent channel interference (at $N\pm 1$ and $N\pm 2$ channels) with its Own System.....	15
5.2.4	Co-Channel and Adjacent channel interference (at $N\pm 1$ and $N\pm 2$ channels) of the ISDB-T to TV 3.0 PHY system .....	15
5.2.5	Impulsive Noise .....	16
5.2.6	Single echo static multipath interference.....	17
<b>6</b>	<b>Testing and Evaluation Results – Phase 3</b> .....	<b>17</b>
6.1	<i>Identification of the candidate technologies</i> .....	18
6.2	<i>Candidate Technology A</i> .....	18
6.2.1	Documentation Analysis .....	18
6.2.2	Test Results .....	19
6.2.2.1	Laboratory Tests .....	21
6.2.2.1.1	Device Verification Tests .....	21
6.2.2.1.1.1	RF frequency accuracy (precision).....	21
6.2.2.1.1.2	Phase noise of local oscillators.....	22
6.2.2.1.1.3	RF/IF signal power.....	22
6.2.2.1.1.4	RF out of band emissions and linearity characterization (Spectrum Mask) .....	23
6.2.2.1.1.5	I/Q analysis – Constellation and MER.....	40
6.2.2.1.2	Evaluation Tests .....	46
6.2.2.1.2.1	C/N - Carrier power vs AWGN.....	46
6.2.2.1.2.2	C/N - Carrier power vs Noise Power over Rayleigh and AWGN Channels.....	46
6.2.2.1.2.3	Receiver maximum and minimum power levels.....	50

- 6.2.2.1.2.4 Co-channel Interference with its own system..... 51
- 6.2.2.1.2.5 Co-channel and adjacent channel interference (at N±1 and N±2 channels) to ISDB-T..... 52
- 6.2.2.1.2.6 Adjacent channel interference (at N±1 and N±2 channels) with its Own System..... 53
- 6.2.2.1.2.7 Co-Channel and Adjacent channel interference (at N±1 and N±2 channels) of the ISDB-T to Advanced ISDB-T..... 54
- 6.2.2.1.2.8 Impulsive noise..... 55
- 6.2.2.1.2.9 Single echo static multipath interference..... 57
- 6.2.2.1.2.10 Channel bonding..... 58
- 6.2.2.1.2.11 Channel identification stability in frequency reuse-1 condition..... 60
- 6.2.2.1.3 Summary of Test Results..... 61
- 6.3 *Candidate Technology B*..... 62
  - 6.3.1 Documentation Analysis..... 62
  - 6.3.2 Test Results..... 63
    - 6.3.2.1 Laboratory Tests..... 65
      - 6.3.2.1.1 Device Verification Tests..... 65
        - 6.3.2.1.1.1 RF Frequency Accuracy (precision)..... 66
        - 6.3.2.1.1.2 Phase Noise of Local Oscillators..... 66
        - 6.3.2.1.1.3 RF Signal Power..... 66
        - 6.3.2.1.1.4 RF Out of Band Emissions and Linearity Characterization (Spectrum Mask)..... 67
        - 6.3.2.1.1.5 I/Q Analysis – Constellation and MER..... 74
      - 6.3.2.1.2 Evaluation Tests..... 78
        - 6.3.2.1.2.1 C/N – Carrier power vs AWGN..... 78
        - 6.3.2.1.2.2 C/N – Carrier power vs Noise Power in Rayleigh and AWGN Channels..... 79
        - 6.3.2.1.2.3 Receiver Maximum and Minimum Level..... 83
        - 6.3.2.1.2.4 Co-channel Interference with own system..... 84
        - 6.3.2.1.2.5 Co-channel and Adjacent Channel Interference (at N±1 and N±2 channels) to ISDB-T..... 85
        - 6.3.2.1.2.6 Adjacent channel interference (at N±1 and N±2 channels) with its Own System..... 86
        - 6.3.2.1.2.7 Co-Channel and Adjacent channel interference (at N±1 and N±2 channels) of the ISDB-T to ATSC 3.0..... 86
        - 6.3.2.1.2.8 Impulse Noise..... 86
        - 6.3.2.1.2.9 Single Echo Static Multipath Interference..... 88
        - 6.3.2.1.2.10 Channel Bonding..... 89
        - 6.3.2.1.2.11 Channel Identification Stability in Frequency Reuse-1 condition..... 91
      - 6.3.2.1.3 Summary of Tests Results..... 92
- 6.4 *Candidate Technology C*..... 93
  - 6.4.1 Documentation Analysis..... 94
  - 6.4.2 Test Results..... 94
    - 6.4.2.1 Laboratory Tests..... 96
      - 6.4.2.1.1 Device Verification Tests..... 96
        - 6.4.2.1.1.1 RF frequency accuracy (precision)..... 96
        - 6.4.2.1.1.2 Phase noise of local oscillators..... 97

6.4.2.1.1.3 RF signal power ..... 97

6.4.2.1.1.4 RF out of band emissions and linearity characterization (Spectrum Mask) ..... 98

6.4.2.1.1.5 I/Q analysis – Constellation and MER..... 105

6.4.2.1.2 Evaluation Tests ..... 105

6.4.2.1.2.1 C/N - Carrier power vs AWGN..... 106

6.4.2.1.2.2 C/N - Carrier power vs Noise Power over Rayleigh and AWGN Channels..... 106

6.4.2.1.2.3 Receiver maximum and minimum power levels..... 109

6.4.2.1.2.4 Co-channel Interference with its own system..... 110

6.4.2.1.2.5 Co-channel and adjacent channel interference (at N±1 and N±2 channels) to ISDB-T..... 111

6.4.2.1.2.6 Adjacent channel interference (at N±1 and N±2 channels) with its Own System..... 111

6.4.2.1.2.7 Co-Channel and Adjacent channel interference (at N±1 and N±2 channels) of the ISDB-T to 5G Broadcast..... 111

6.4.2.1.2.8 Impulsive noise ..... 111

6.4.2.1.2.9 Single echo static multipath interference..... 113

6.4.2.1.2.10 Channel bonding ..... 113

6.4.2.1.2.11 Channel identification stability in frequency reuse-1 condition..... 113

6.4.2.1.3 Summary of Test Results ..... 114

**Appendix I. Information for Reference ..... 116**

*I.1 Co-channel and Adjacent Channel Interference with ISDB-T..... 116*

# 1 Introduction

The SBTVD Forum was created by the Brazilian Presidential Decree # 5 820 / 2006, to advise the Brazilian Government regarding policies and technical issues related to the approval of technical innovations, specifications, development, and implementation of the Brazilian Digital Terrestrial Television System (SBTVD). The SBTVD Forum is composed of representatives of the broadcasting, academia, transmission, reception, and software industry sectors, and has the participation of Brazilian Government representatives as non-voting members.

Free-to-air terrestrial television is the main audiovisual distribution platform in Brazil, covering almost all Brazilian households and used in more than 70% of them. It secures to most of the Brazilian population a free-of-charge, universal and democratic access to information and entertainment, made by Brazilians for Brazilians. It is, therefore, an important social cohesion, national, and cultural identity factor.

For its first generation Digital Terrestrial Television system, after thorough testing and careful studies, the Brazilian Government adopted in June 2006 the ISDB-T standard, incorporating technological innovations that were deemed relevant, such as MPEG-4 AVC (H.264) video coding, MPEG-4 AAC audio coding, an appropriate closed caption character set for the Brazilian Portuguese, and a new middleware for interactive applications (Ginga).

The SBTVD Forum developed the first SBTVD standards, that were published in 2007, allowing the official opening of transmissions in that same year. Since then, the standards have been continuously revised and updated by the Forum. The technological innovations proposed by Brazil were incorporated into the International ISDB-T standard, which is currently adopted by 20 countries.

In 2016, Brazil started a safe and gradual analog TV switch-off process, that was designed to assure that no one would be deprived of the terrestrial free-to-air TV. The process was divided into two stages: in the first stage (2016 to 2019) the analog television switch-off was performed in all the state capitals, metropolitan areas, and other areas where it was required to release the 700 MHz band; on the second stage (up to 2023) the analog television switch-off would be performed in the remaining of the country. During the first stage, 1 362 cities in 47 different clusters were impacted, accounting for nearly 128 million people (62% of the population). More than 12 million Digital TV reception kits were distributed for low-income families. The analog switch-off had no significant impact on the free-to-air terrestrial TV audience. Regarding the second stage, the remaining 38% of the population (more than 79 million people) is distributed in 4 208 cities. After the implementation of Digital Terrestrial Television, Brazil adopted an industrial policy that determined that all flat-panel TVs manufactured from 2012 must have an integrated Digital TV receiver and from 2013 no more CRT TVs were manufactured. Therefore, it is anticipated, based on the expected product lifetimes, that by 2023 Brazil would have nearly all its TV sets already equipped with an integrated Digital TV receiver, thus facilitating the analog television switch-off without additional Digital TV reception kits distribution.

As the Brazilian digital television switch-over began, the SBTVD Forum started considering the next steps for the evolution of the Brazilian Television. The analog TV (that we conventionally call "TV 1.0"), which started in Brazil in 1950, was black and white with monophonic sound. Then, some backward-compatible improvements (that we conventionally call "TV 1.5"), such as color (in the 1970s), stereo sound and closed caption (in the 1980s) were added to it. From 2007, the first generation of Digital Terrestrial Television (that we conventionally call "TV 2.0") was introduced in Brazil, bringing high-definition video, surround sound, mobile reception, and interactivity. Since then, the technological landscape has changed a lot. The rhythm of development and introduction of innovations is increasingly accelerated. These innovations create new consumption habits and increase the expectations of technological services users regarding the quality and convenience of these services. Since the introduction of SBTVD, new immersive audio and video formats have

emerged, and are already present in the new TV sets available in the market. The TV sets currently available have resolution and contrast greater than those supported in the first generation SBTVD standard. That is the opposite of the market situation when Digital TV was launched in Brazil, as the HDTV sets offer was very low. The availability and the speed of Internet access in Brazil, especially in metropolitan areas, increased significantly, enabling the consumption of on-demand audiovisual content. This connectivity is already in use by TV sets (Smart TVs) and by broadcasters' Over-The-Top (OTT) offers. However, in the first generation SBTVD standard, there was not an integration between the broadcasting service and the Internet content offer. Furthermore, new techniques for signal coding, transport, and modulation were also developed, allowing greater efficiency in audiovisual transmission. Many Digital Terrestrial Television systems have also been evolving, including in this evolution not only enhancements in quality and efficiency but also new convergent services between the broadcasting and the Internet. Based on this technological landscape, the SBTVD Forum recognized the necessity to evolve the SBTVD. It also acknowledged that changes in the physical layer, the transport layer, and/or audiovisual coding would not be backward-compatible. Nevertheless, the transition to a new generation of Digital Terrestrial Television is a long process, based on the investments required for both broadcasters and consumers and the expected life span of TV transmitters and receivers. It was, therefore, deemed necessary to increase the life span of the existing Digital Terrestrial Television system as much as possible through a backward-compatible evolution (a project we called "TV 2.5") and to start the development of the next generation Digital Terrestrial Television system (the project we called "TV 3.0").

The "TV 2.5" project comprised two aspects: broadcast-broadband integration and audiovisual quality. The first aspect involved the development of a new receiver profile for the middleware Ginga (receiver profile D, a.k.a. "DTV Play"), addressing use cases such as on-demand video, synchronized companion device, audiovisual enhancement over the Internet, and targeted content. The second aspect was addressed through the introduction of three new optional immersive audio codecs (MPEG-H Audio, E-AC-3 JOC, and AC-4) while retaining MPEG-4 AAC main audio for backward-compatibility, and through the introduction of two new optional HDR video formats (SL-HDR1 dynamic metadata and HLG "preferred transfer characteristics" signaling) while keeping MPEG-4 AVC (H.264) / 8-bit / BT.709 / 1080i for backward-compatibility. The revision of the SBTVD standards containing both "TV 2.5" aspects has already been published (available at <https://forumsbtvd.org.br/legislacao-e-normas-tecnicas/normas-tecnicas-da-tv-digital/english/>).

For the "TV 3.0" project, the SBTVD Forum, after agreeing on its requirements (use cases and corresponding technical specifications), decided to release a Call for Proposals (available at <https://forumsbtvd.org.br/wp-content/uploads/2020/07/SBTVDTV-3-0-CfP.pdf>) for any interested organization to submit its proposed candidate technologies for any of the system components or sub-components. The new system is expected to start operating within the next few years, but based on the Brazilian experience on the transition from analog to digital television, the complete transition from the current SBTVD to the TV 3.0 is expected to last at least 15+ years.

As described in the aforementioned Call for Proposals document, the response to the Call for Proposals was divided into two phases.

Phase 1 responses comprised the identification of each proposed candidate technology and appropriate contact persons and filling the compliance form of the components or sub-components corresponding to the proposed candidate technology.

Phase 2 responses comprised providing the full specification of the proposed candidate technology, adhering to the SBTVD Forum Intellectual Property Rights Policy, and the additional requirements considering general information and resources needed for evaluating and comparing the proposed candidate technologies. The "TV 3.0 CfP Phase 2 / Testing and Evaluation" document (available at <https://forumsbtvd.org.br/wp->

[content/uploads/2021/03/SBTVD-TV\\_3\\_0-P2\\_TE\\_2021-03-15.pdf](#)) provides further information on Phase 2, along with the test procedures for evaluating and comparing the proposals of candidate technologies.

The Call for Proposals was open from 17 July 2020 to 30 November 2020. It received in total, considering its 6 system components (Over-the-air Physical Layer, Transport Layer, Video Coding, Audio Coding, Captions, and Application Coding), 36 responses from 21 different organizations worldwide. Some similar proposals were merged for the sake of Phase 2 testing and evaluation, resulting in 30 candidate technologies.

Phase 2 tests were funded by the Brazilian Ministry of Communications through the Brazilian National Council for Scientific and Technological Development (CNPq, *Conselho Nacional de Desenvolvimento Científico e Tecnológico*). The Over-the-air Physical Layer candidate technologies were tested by the Mackenzie Presbyterian University (laboratory tests) and Fluminense Federal University (field tests) from 05 July 2021 to 03 December 2021. Phase 2 Over-the-air Physical Layer laboratory tests report is available at [https://forumsbtvd.org.br/wp-content/uploads/2021/12/SBTVD-TV\\_3\\_0-PL-Lab-Report.pdf](https://forumsbtvd.org.br/wp-content/uploads/2021/12/SBTVD-TV_3_0-PL-Lab-Report.pdf) and field tests report is available at [https://forumsbtvd.org.br/wp-content/uploads/2021/12/SBTVD-TV\\_3\\_0-PL-Field-Report.pdf](https://forumsbtvd.org.br/wp-content/uploads/2021/12/SBTVD-TV_3_0-PL-Field-Report.pdf).

At the end of Phase 2, the SBTVD Forum concluded that complementary laboratory and field tests would be needed in the Phase 3 to select the appropriate technology for the Over-the-air Physical Layer among the current candidate technologies (Advanced ISDB-T, ATSC 3.0 and 5G Broadcast – the DTMB-A proposal was withdrawn by the proponent). It was agreed that only the two candidate technologies that demonstrate the best fit with the specific requirements of the TV 3.0 Project in the laboratory tests would continue in the field tests. It also concluded that it was necessary to carry out a real-time video coding subjective quality assessment using the video coding technologies selected for the TV 3.0 Project (VVC and LCEVC) to determine the required bit rate for the Over-the-air Physical Layer to enable delivering audiovisual quality superior to that of the first-generation Brazilian DTTB system.

In April 2023, the Brazilian Presidential Decree No. 11,484, which provides the guidelines for the evolution of the Brazilian Digital Terrestrial Television System and for ensuring the availability of radio spectrum for its deployment, was published (available at [http://www.planalto.gov.br/ccivil\\_03/\\_ato2023-2026/2023/decreto/D11484.htm](http://www.planalto.gov.br/ccivil_03/_ato2023-2026/2023/decreto/D11484.htm), in Portuguese only).

It establishes that the next-generation Digital Terrestrial Television Broadcasting (DTTB) system in Brazil, called TV 3.0, shall have the following characteristics:

- I. audiovisual quality superior to that of the first-generation Brazilian DTTB system;
- II. fixed reception, with external and internal antenna, and mobile reception;
- III. integration between contents transmitted by the broadcasting service and over the internet;
- IV. app-based user interface;
- V. content segmentation according to viewers' geographic location;
- VI. customization of content according to viewers' preferences;
- VII. optimized use of the radio frequency spectrum destined for terrestrial television broadcasting; and
- VIII. new forms of access to cultural, educational, artistic, and informative contents.

The characteristics I, II, V and VII have a direct relationship with the Over-the-air Physical Layer and are in line with the requirements defined in the Call for Proposals.

The Phase 3 Over-the-air Physical Layer laboratory tests were carried out by Mackenzie Presbyterian University from April to September 2023, the real-time video coding subjective quality assessment is being carried out at Brasília University from June to December 2023 and the field tests will be carried out by the Fluminense Federal University from December 2023 to May 2024. These tests, as well as Transport Layer and Application Coding R&D activities (from April 2023 to September 2024), are all being carried out under the coordination of the SBTVD Forum and funded by the Brazilian Ministry of Communications through the Brazilian National Education and Research Network (RNP, *Rede Nacional de Ensino e Pesquisa*).

Further information regarding the TV 3.0 Project can be obtained at: [https://forumsbtvd.org.br/tv3\\_0/](https://forumsbtvd.org.br/tv3_0/).

This document contains the results of the Phase 3 Over-the-air Physical Layer laboratory tests to support (alongside the results of the other tests and the market and intellectual property assessments) the SBTVD Forum in recommending the appropriate technology for the Over-the-air Physical Layer of the next generation of digital terrestrial television in Brazil.

It is important to highlight that, in this process, the SBTVD Forum has a propositional role, with the Brazilian Government alone being responsible for making any decisions about the standards applicable to broadcasting service in Brazil.

## 2 Research Team

This report was developed by Mackenzie Presbyterian University Digital TV Laboratory:

Cristiano Akamine, Mackenzie and SBTVD Forum Coordinator of Transport and Physical Layer - <http://lattes.cnpq.br/0394598624993168>

Daniel Pedroso Neri, Mackenzie - <http://lattes.cnpq.br/4560029902159000>

Edson Tafeli Carneiro dos Santos, Mackenzie - <http://lattes.cnpq.br/0161192178607515>

Fadi Jerji, Mackenzie - <http://lattes.cnpq.br/8465196319661656>

Guilherme Gimenes Gennari, Mackenzie - <http://lattes.cnpq.br/3218279588443167>

João Pedro Borges da Silva, Mackenzie - <http://lattes.cnpq.br/7639939231073109>

João Vadoros, Vadoros - <http://lattes.cnpq.br/2127415175631377>

Larissa Aparecida de Castro Souza, Mackenzie - <http://lattes.cnpq.br/9680302502867239>



Luciano Neves dos Santos Junior, Mackenzie - <http://lattes.cnpq.br/9039372956721861>

Marcelo Bender Perotoni, UFABC - <http://lattes.cnpq.br/6536009557203935>

Marcos Stefanelli Vieira, Mackenzie - <http://lattes.cnpq.br/7586109476484841>

Paulo Batista Lopes, Mackenzie - <http://lattes.cnpq.br/1678715490240349>

Ricardo Seriacopi Rabaça, Mackenzie - <http://lattes.cnpq.br/4655443426079175>

Yuzo Iano, Unicamp - <http://lattes.cnpq.br/1819902045004845>

We also had the collaboration of the SBTVD Forum members, in particular:

Luiz Fausto – Chair, Technical Module, SBTVD Forum

### 3 Glossary

3GPP	Third Generation Partnership Project
ABNT	<i>Associação Brasileira de Normas Técnicas</i> (Brazilian Technical Standards Association)
ATSC	<i>Advanced Television System Committee</i>
ATSC 3.0	<i>Newest Version of Advanced Television System Committee Standard</i>
AWGN	Additive White Gaussian Noise
BCH	Bose–Chaudhuri–Hocquenghem
BER	Bit Error Rate
CFP	Call for Proposals
C/N	Carrier-to-Noise Ratio
C/Neq	Carrier-to-Equivalent Noise Ratio
CL	Core Layer

DIBEG	Digital Broadcasting Experts Group
DTT	Digital Terrestrial Television
DTTB	Digital Terrestrial Television Broadcasting
DUT	Devices Under Test
EL	Enhanced Layer
eMBMS	evolved Multimedia Broadcast Multicast Service
EnTV	Enhanced Television
FER	Frame Error Rate
FFT	Fast Fourier Transform
GPS	Global Positioning System
IF	Intermediary Frequency
IFFT	Inverse Fourier Transform
ISDB-T	Integrated Services Digital Broadcasting-Terrestrial
ITU	International Telecommunications Union
LA	Layer A
LB	Layer B
LDM	Layered Division Multiplexing
MCH	Multicast Channel
MCS	Modulation and Coding Scheme
MER	Modulation Error Rate

MIC	Ministry of Internal Affairs and Communications
MIMO	Multiple-Input and Multiple-Output
MPU	Mackenzie Presbyterian University
NBR	<i>Norma Brasileira Regulamentadora</i> (Brazilian National Standard)
Neq	Equivalent Noise Power
NHK	Japan Broadcasting Corporation
NUC	Non-Uniform Constellation
OFDM	Orthogonal Frequency-Division Multiplexing
P1dB	1 dB compression point
PER	Packet Error Rate
PLP	Physical Layer Pipes
PPS	Pulse Per Second
PR	Protection Ratio
QEF	Quasi Error Free
reuse-1	The use of the same RF channel by independent stations covering adjacent service areas
RF	Radio Frequency
SBTVD	<i>Sistema Brasileiro de Televisão Digital</i> (Brazilian Digital Television System)
SFN	Single Frequency Network
STB	Set-Top Box
TOV	Threshold Of Visibility

TV	Television
UC	Uniform Constellation
UHF	Ultra High Frequency
VHF	Very High Frequency

## 4 TV 3.0 Architecture

The TV 3.0 system components described in this document reflect the reference TV 3.0 architecture, as depicted in Figure 1.

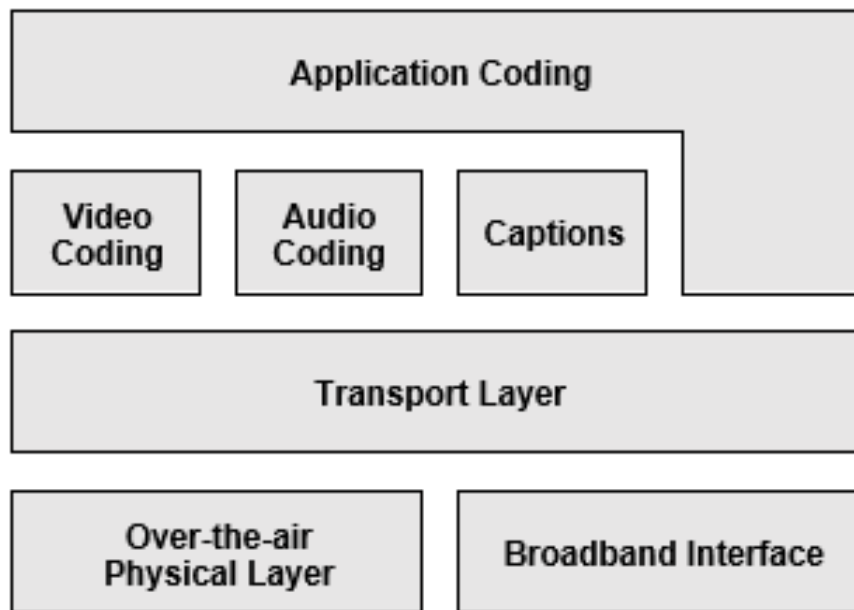


Figure 1 - TV 3.0 Architecture

For further information about TV 3.0 architecture, please refer to the TV 3.0 Call for Proposals (CFP) document (available at <https://forumsbtvd.org.br/wp-content/uploads/2020/07/SBTVDTV-3-0-CfP.pdf>).

## 5 TV 3.0 Phase 3 Testing and Evaluation

Please refer to Section 4 of the “TV 3.0 CfP Phase 2 / Testing and Evaluation” document (available at [https://forumsbtvd.org.br/wp-content/uploads/2021/03/SBTVD-TV\\_3\\_0-P2\\_TE\\_2021-03-15.pdf](https://forumsbtvd.org.br/wp-content/uploads/2021/03/SBTVD-TV_3_0-P2_TE_2021-03-15.pdf)) for further information on the testing and evaluation procedures.

In the same way as in Phase 2, Physical layer testing in Phase 3 was separated into two steps, device verification and performance testing.

In Phase 3, the physical layer is validated with MIMO systems only. All adjustments in the test procedures, such as signal level adjustment, among others, are indicated in the performance test procedures of this document.

All Phase 3 test items are presented in this document, with description of any changes on the procedures.

### 5.1 Device Verification Tests

#### 5.1.1 RF frequency accuracy (precision)

The RF frequency precision was measured with a spectrum analyzer. The Devices Under Test (DUT) and the spectrum analyzer were connected to Global Positioning System (GPS) 10 MHz reference. Refer to the Figure 8 of the “TV 3.0 CfP Phase 2 / Testing and Evaluation” document for the test setup.

### 5.2 Evaluation Tests

#### 5.2.1 C/N – Carrier power vs Noise Power in Rayleigh and AWGN Channels

The C/N - Carrier power vs. Noise Power in Rayleigh and AWGN Channel were tested, following the procedure established in Section 4.2.3.2.1 of the “TV 3.0 CfP Phase 2 / Testing and Evaluation” document. In this phase, the Keysight channel emulator, Prosim F16, is used to emulate the terrestrial channel test models described in Tables 1 to 6 of the “TV 3.0 CfP Phase 2 / Testing and Evaluation” document. Figure 2 shows the test setup. Cross-polarization and AWGN can be configured internally in this channel emulator.

The emulated channels were tested as per the ITU recommendations described on Phase 2 and with additional speed settings to achieve more evaluation data. Initially, RF1, RF2A, RF2B, RF3A, RF3B and RF4 were tested with constant channel model, and results are presented under 0 km/h header. Then, all channels were tested employing taps that adhere to the Rayleigh fading and Jake model Doppler effect at the speed of 3 km/h for RF1, RF2A and RF2B as well as 50 and 120 Km/h for RF3A, RF3B and RF4, according to ITU.

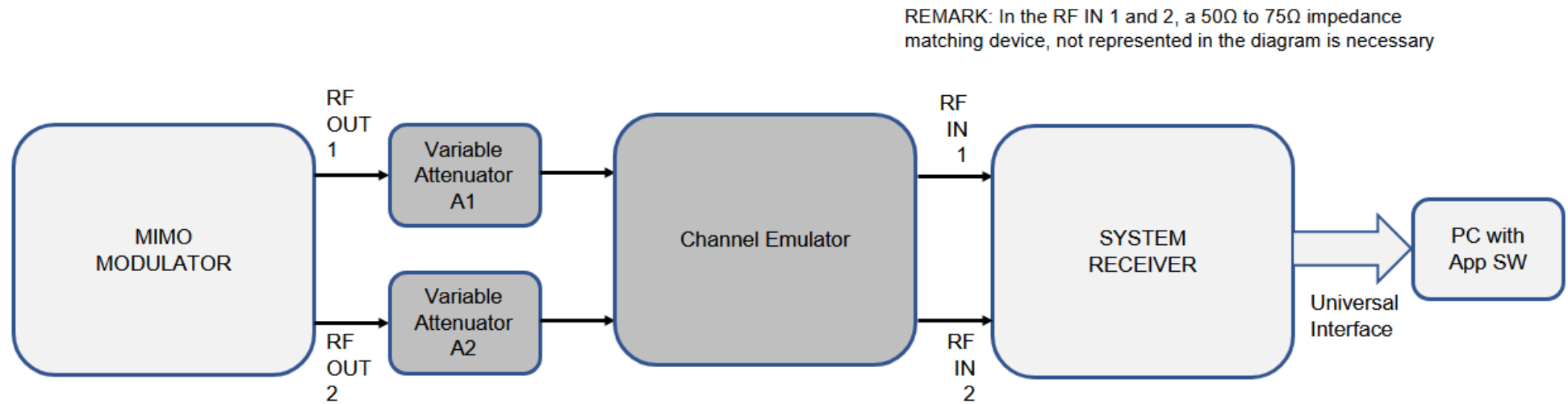


Figure 2 - Test setup for C/N – Carrier power vs Noise Power in Rayleigh and AWGN Channels

### 5.2.2 Co-channel and Adjacent Channel Interference (at $N\pm 1$ and $N\pm 2$ channels) to ISDB-T

The tests for co-channel and Adjacent Channel interference to ISDB-T were conducted with the test setup established in Section 4.2.3.2.5 of the test procedure of Phase 2. The tests were conducted by combining the MIMO polarizations, as shown in Figure 3.

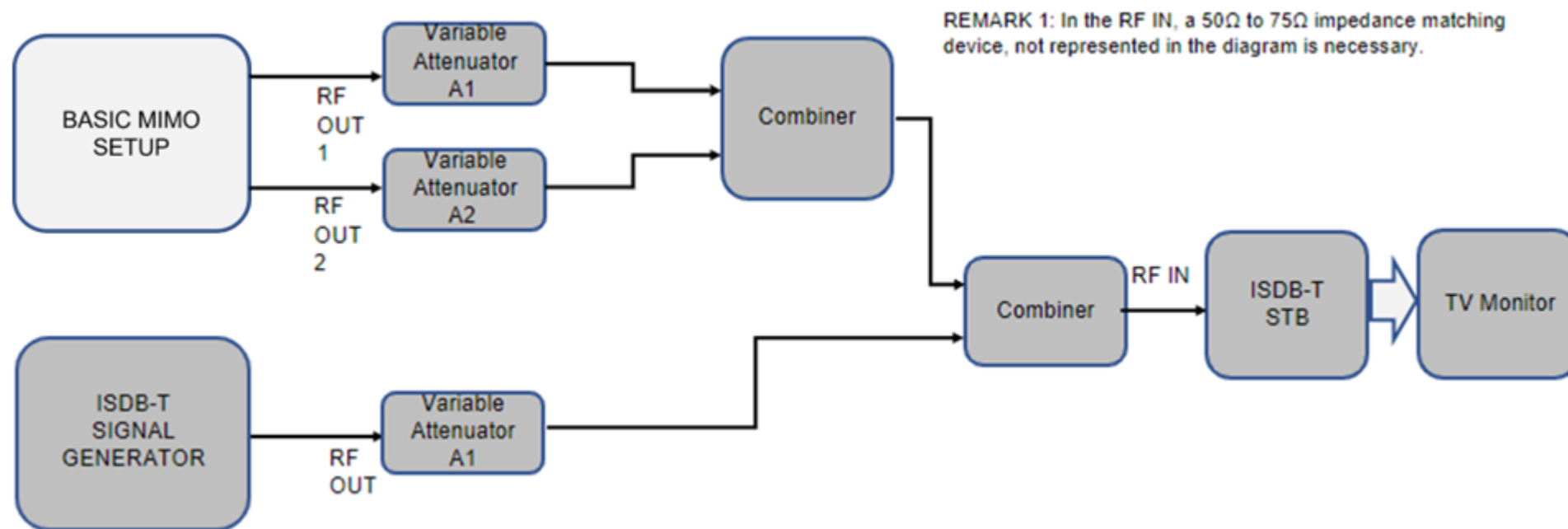


Figure 3 - Test setup for Co-channel and Adjacent Channel Interference (at  $N\pm 1$  and  $N\pm 2$  channels) to ISDB-T

### 5.2.3 Adjacent channel interference (at $N\pm 1$ and $N\pm 2$ channels) with its Own System

Adjacent channel interference was tested, following the procedure set out in Section 4.2.3.2.4 of the “TV 3.0 CfP Phase 2 / Testing and Evaluation” document, varying the undesirable channel by  $N\pm 1$  and  $N\pm 2$ .

### 5.2.4 Co-Channel and Adjacent channel interference (at $N\pm 1$ and $N\pm 2$ channels) of the ISDB-T to TV 3.0 PHY system

The tests for co-channel and Adjacent Channel interference of ISDB-T to TV 3.0 PHY system were conducted using the test setup of Figure 4. The test procedure is like Section 4.2.3.2.4 of the test procedure of Phase 2 but uses ISDB-T as an undesirable channel.

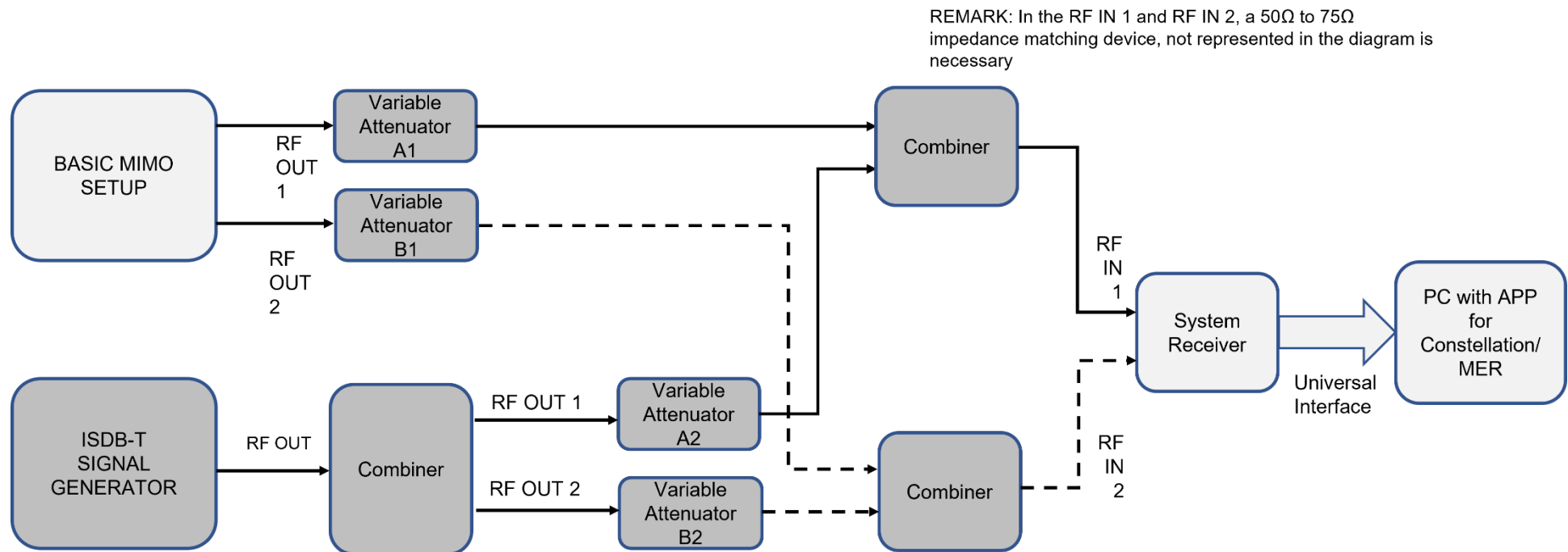


Figure 4 - Test setup for Co-Channel and Adjacent channel interference (at  $N\pm 1$  and  $N\pm 2$  channels) of the ISDB-T to own system

### 5.2.5 Impulsive Noise

Impulsive noise was added in both polarizations according to Figure 5, and procedure established in Section 4.2.3.2.6 of the “TV 3.0 CfP Phase 2 / Testing and Evaluation” document.



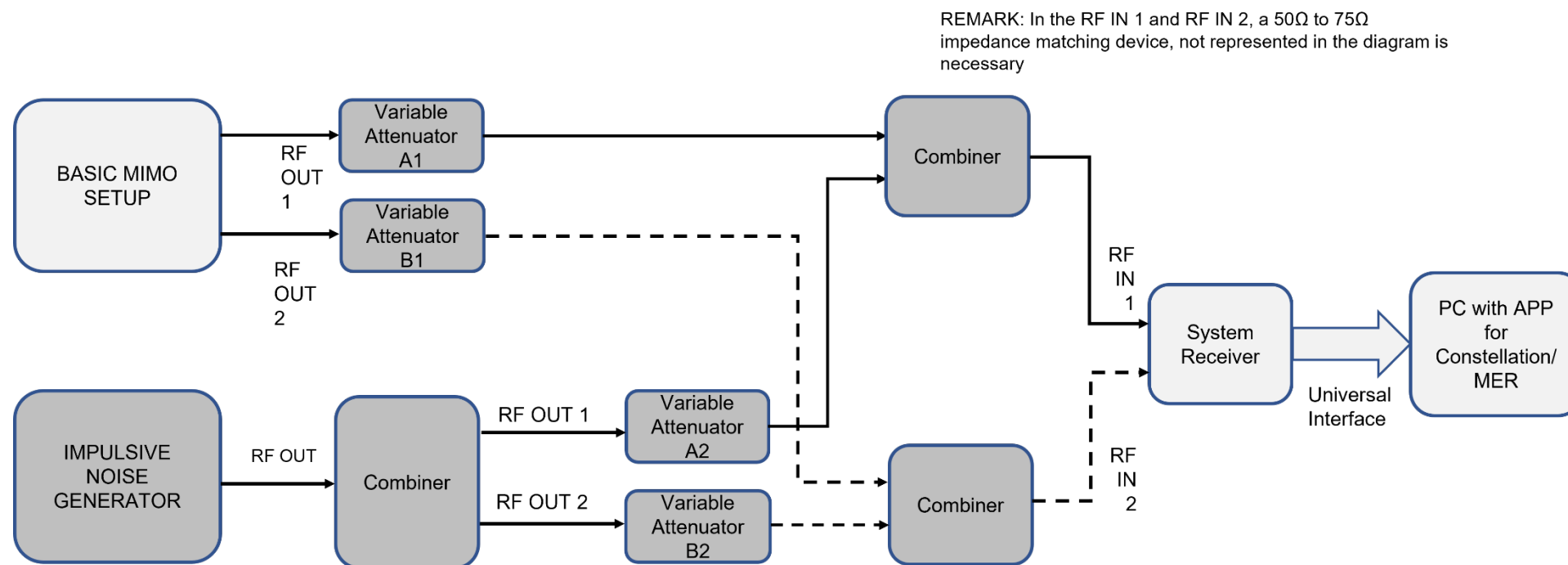


Figure 5 - Test setup for Impulsive Noise

### 5.2.6 Single echo static multipath interference

The Single echo static multipath interference was tested, following the procedure established in Section 4.2.3.2.7 of the “TV 3.0 CfP Phase 2 / Testing and Evaluation” document. In this phase, the Keysight channel emulator, Prosim F16, was used to emulate a single echo in both polarizations. Figure 2 shows the test setup.

## 6 Testing and Evaluation Results – Phase 3

The Digital TV Laboratory of the School of Engineering of Mackenzie Presbyterian University (MPU) conducted the tests presented in this report. The headquarters of MPU is in the central region of the city of Sao Paulo, Brazil.

## 6.1 Identification of the candidate technologies

Throughout this report the candidate technologies are referred to by letters from "A" to "C". Table 1 shows the correspondence with their real names.

**Table 1 - Candidate Technologies**

Candidate Technology A	Advanced ISDB-T
Candidate Technology B	ATSC 3.0
Candidate Technology C	5G Broadcast / EnTV

## 6.2 Candidate Technology A

Advanced ISDB-T is one of the candidate technologies for the Second Generation Digital Terrestrial TV system of Japan, developed by Japan Broadcasting Corporation (NHK), to be elected by the Japanese Government in 2023. As such, it is not a standardized system yet. It was selected by the Japanese Ministry of Internal Affairs and Communications (MIC) and the Digital Broadcasting Experts Group (DiBEG), an organization responsible for the promotion of the ISDB-T - Digital TV System developed in Japan, to be submitted as a candidate to the TV 3.0 system.

### 6.2.1 Documentation Analysis

Although the system is still in development, the proponent submitted a Specification Document, covering all the Physical Layer characteristics. The proponent also presented a Test Report, which was conducted in its own premises before the equipment was shipped to the SBTVD Forum.

The main documents presented by the proponent are listed as follows:

- [1] DiBEG - SBTVD TV 3.0 CfP Phase 1 Physical Layer response
- [2] Draft Transmission system for Advanced ISDB-T (draft) - 1st July 2021 – Digital Broadcasting Experts Group
- [3] Response to TV3.0 project CfP Phase2 - Laboratory Test Report for Advanced ISDBT Physical Layer - 2nd, July. 2021 - DiBEG, Japan
- [4] Response to TV3.0 project CfP Phase2 - Physical Layer - 2nd July 2021
- [5] PROPOSED REVISION OF REPORT ITU-R BT.2485 - Advanced network planning and transmission methods for enhancements of digital terrestrial television broadcasting – Contribution for WP-6A – October 2021 Meeting
- [6] PROPOSED REVISION OF REPORT ITU-R BT.2343-6 - Collection of field trials of UHD TV over DTT networks - Contribution for WP-6A – October 2021 Meeting

Besides the above document, Instruction Manuals of the equipment delivered to the Test Lab, as well as a series of papers concerning Digital Broadcasting, were submitted but are not listed here. Also, many meetings between Test Lab and proponent were convened, during the test period, on almost a weekly basis.

## 6.2.2 Test Results

Table A 1 shows the list of equipment received by the test laboratory, which was sent by the proponent.

**Table A 1 - List of equipment provided by Advanced ISDB-T**

Equipment	Quantity
Advanced Modulator - 0428A	2
Multiplexer - Mod. 0416A – 003	2
Impulsive Noise Generator / Up Converter Eiden - Mod. 1908-00	2
Demodulator Socionext - SC1502A-B03	2
GOP Generator - NS-G8600	1
BER Packet Analyzer – 7709C	1
RF MIMO Capturer & Player – 4422A	1
Notebook PC, Dell Latitude 3500	1
Audio Analyser SP105-12G-32	1
MMT / TLV Station	1
Channel Bond Combiner OTH001 - TX Station Side	1
Channel Bond Divider OTH001 - TX Station Side	1
Decoder 4K XJive MMT02R	1
Encoder 2K/4K– NEC MF4400 /YE-9300	1
BlackBox GbE Switch LGB2126A	1
Master Clock – 5601 MSC	2
Various cables, Coaxial Attenuators and RF Combiner/Divide	Set

Amongst many possible configurations that the Advanced ISDB-T system may operate, it was previously agreed with the proponent the adoption of the modulation/codification parameters of Table A 2 and

Table A 3, for the transmission of 1080p signal over a channel of  $C/N \leq 0$  dB. The QEF adopted was a Packet Error Rate (PER) of  $10^{-4}$  before Bose–Chaudhuri–Hocquenghem (BCH).

**Table A 2 - Single Layer MIMO 2x2 Configurations**

Parameter	Config 1	Config 5	Config 10	Config 11
	Layer A (LA)	LA	LA	LA
<b>Bandwidth</b>	6 MHz	6 MHz	6 MHz	6 MHz
<b>Useful Bandwidth</b>	5.831 MHz	5.831 MHz	5.831 MHz	5.831 MHz
<b>Modulation</b>	QPSK	QPSK	256QAM	256QAM
<b>Constellation</b>	UC	UC	NUC	NUC
<b>Error Correction</b>	LDPC+BCH	LDPC+BCH	LDPC+BCH	LDPC+BCH
<b>FEC</b>	3/16	4/16	10/16	8/16
<b>iFFT Size</b>	16384	16384	16384	16384
<b>GI Ratio</b>	800/16384 (126 $\mu$ s)	800/16384 (126 $\mu$ s)	800/16384 (126 $\mu$ s)	800/16384 (126 $\mu$ s)
<b>Dx</b>	6	6	6	6
<b>Dy</b>	2	2	4	4
<b>Time Interleaver</b>	l = 3	l = 3	l = 3	l = 3
<b>Number of Segments</b>	35	35	35	35
<b>Bit Rate (Mbps)</b>	3.64	4.88	51.52	41.02

**Table A 3 - Dual Layer MIMO 2x2 Configurations**

Parameter	Config 2		Config 9	
	LA	Layer B (LB)	LA	LB
<b>Bandwidth</b>	6 MHz		6 MHz	
<b>Useful Bandwidth</b>	5.831 MHz		5.831 MHz	
<b>Modulation</b>	QPSK	256QAM	QPSK	256QAM
<b>Constellation</b>	UC	NUC	UC	NUC
<b>Error Correction</b>	LDPC+BCH	LDPC+BCH	LDPC+BCH	LDPC+BCH
<b>FEC</b>	3/16	12/16	4/16	8/16
<b>iFFT Size</b>	16384	16384	16384	16384
<b>GI Ratio</b>	800/16384 (126 $\mu$ s)	800/16384 (126 $\mu$ s)	800/16384 (126 $\mu$ s)	800/16384 (126 $\mu$ s)
<b>Dx</b>	6	6	6	6
<b>Dy</b>	2	2	2	2
<b>Time Interleaver</b>	$l = 3$	$l = 3$	$l = 3$	$l = 3$
<b>Number of Segments</b>	19	16	25	10
<b>Bit Rate (Mbps)</b>	1.98	27.01	3.48	11.23

### 6.2.2.1 Laboratory Tests

The Laboratory Tests are conducted inside a Faraday Cage, to avoid external interferences of TV, Radio, Wi-Fi, and other undesired RF sources, and under controlled temperature and humidity as specified in ABNT NBR 15604 standard.

#### 6.2.2.1.1 Device Verification Tests

The Device Verification tests are performed with the intention to verify the basic characteristics of the sample MIMO Exciter device itself, to give assurance of no significant interference, during the on-site field evaluation tests, on the other TV channels already in operation, and have no intention to be an evaluation item of the candidate TV 3.0 system.

##### 6.2.2.1.1.1 RF frequency accuracy (precision)

The RF frequency accuracy was measured, following the procedure established in Section 5.1.1, at the output of the Up Converter submitted by the proponent. The Up Converter input was connected to the Advanced ISDB-T Modulator IF Output, which was configured to output a CW signal. The measurements are done using external reference (Master Clock). The results are presented in Table A 4 for the modulator A and B.

**Table A 4 - RF Frequency Accuracy**

Channel	Nominal RF Frequency <sup>1</sup> (Hz)	Polarization	Modulator A		Modulator B	
			Deviation (Hz)	Deviation (ppm)	Deviation (Hz)	Deviation (ppm)
IF	037.1500000E+06	H1	- 0.010	0.0003	0.030	0.0008
		V1	0.010	0.0003	0.000	0.0000
10 (192-198 MHz)	195.1428571E+06	H1	- 0.130	0.0007	- 0.520	0.0027
		V1	- 0.130	0.0007	- 0.400	0.0020
30 (566-572 MHz)	569.1428571E+06	H1	- 0.110	0.0002	0.420	0.0007
		V1	- 0.060	0.0001	0.170	0.0003

### 6.2.2.1.1.2 Phase noise of local oscillators

The RF Phase Noise was measured, following the procedure established in Section 4.2.3.1.2 of the “TV 3.0 CfP Phase 2 / Testing and Evaluation” document, at the output of the Up Converter submitted by the proponent. The Up Converter input was connected to the Advanced ISDB-T Modulator IF Output, which was configured to output a CW signal. The measurements are done using external reference (Master Clock) and is presented in Table A 5.

**Table A 5 - RF Phase Noise**

Modulator	Polarization	Integral (100Hz – 6MHz) dBc		
		IF	Channel 10	Channel 30
A	H1	- 43.4	- 45.6	- 47.5
	V1	- 43.9	- 46.1	- 47.5
B	H1	- 45.6	- 47.0	- 48.1
	V1	- 45.6	- 47.1	- 47.7

### 6.2.2.1.1.3 RF/IF signal power

The RF signal power was measured, following the procedure established in Section 4.2.3.1.3 of the “TV 3.0 CfP Phase 2 / Testing and Evaluation” document, at the output of the Up Converter submitted by the proponent. The Up Converter input was connected to the Advanced ISDB-T Modulator IF Output, which was configured to output a CW signal. The measurements are done using external reference (Master Clock) and are presented in Table A 6.

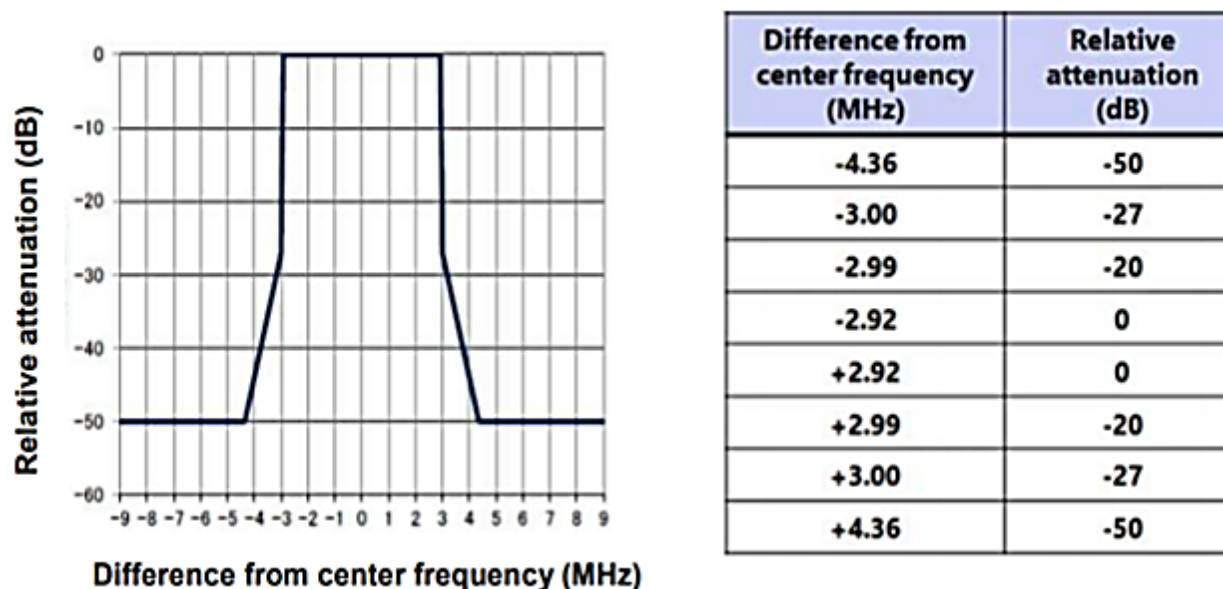
<sup>1</sup> Advanced ISDB-T system uses + (1/7) MHz shift in the central frequency.

**Table A 6 - RF/IF Signal Power for Modulators A and B**

Channel	Nominal RF Frequency <sup>1</sup> (Hz)	Polarization	Measured Power (dBm) Modulator A	Measured Power (dBm) Modulator B
IF	037.1500000E+06	H1	- 9.43	- 9.84
		V1	- 8.89	- 8.56
10 (192-198 MHz)	195.1428571E+06	H1	0.19	0.09
		V1	0.39	0.51
30 (566-572 MHz)	569.1428571E+06	H1	- 0.11	- 0.44
		V1	- 0.12	- 0.41

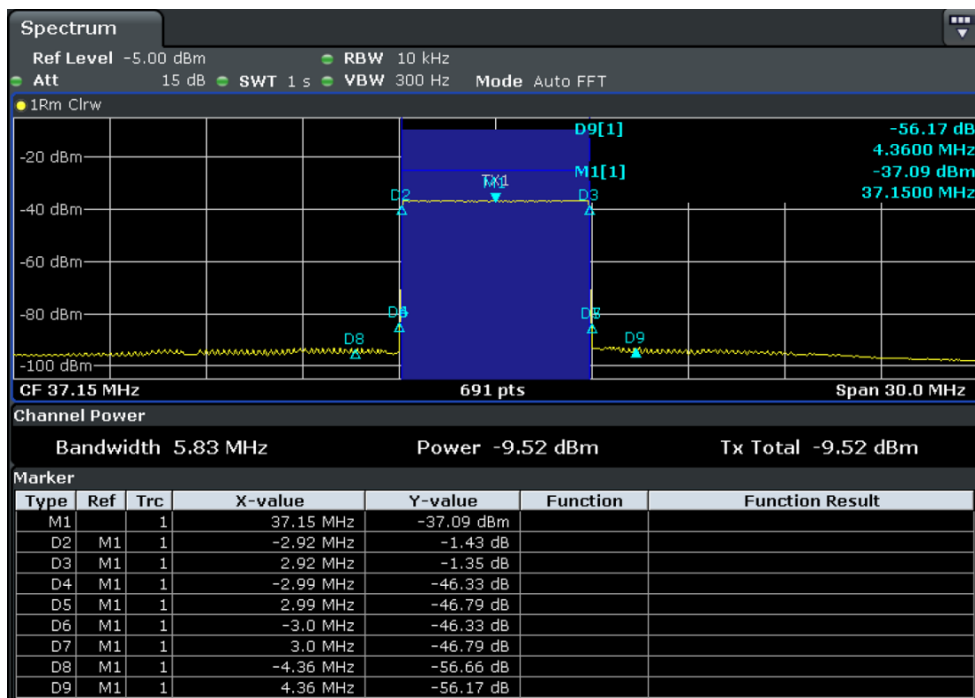
**6.2.2.1.1.4 RF out of band emissions and linearity characterization (Spectrum Mask)**

The proponent informed that the emission mask to be adopted is defined as in Figure A 1.

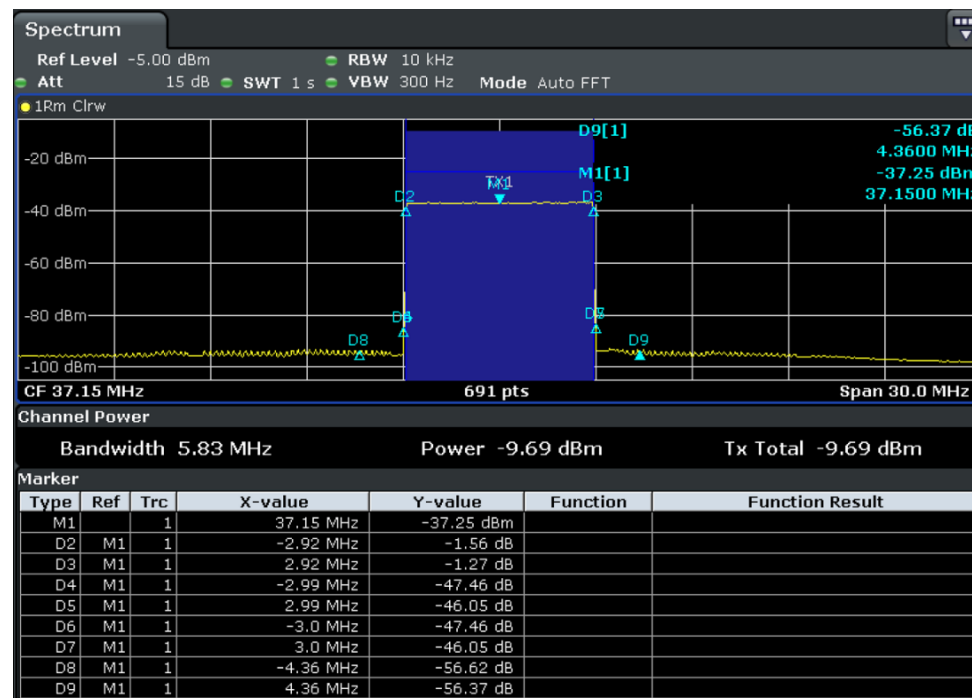


**Figure A 1 - Emission mask specification for Advanced ISDB-T**

The Spectrum Mask was measured, following the procedure established in Section 4.2.3.1.4 of the “TV 3.0 CfP Phase 2 / Testing and Evaluation” document. The spectrum mask in both exciters was analyzed for the Config 1 configuration only and results are presented on Figure A 2 to Figure A 4 for Modulator A and Figure A 5 to Figure A 7 the results for Modulator B.



(a)



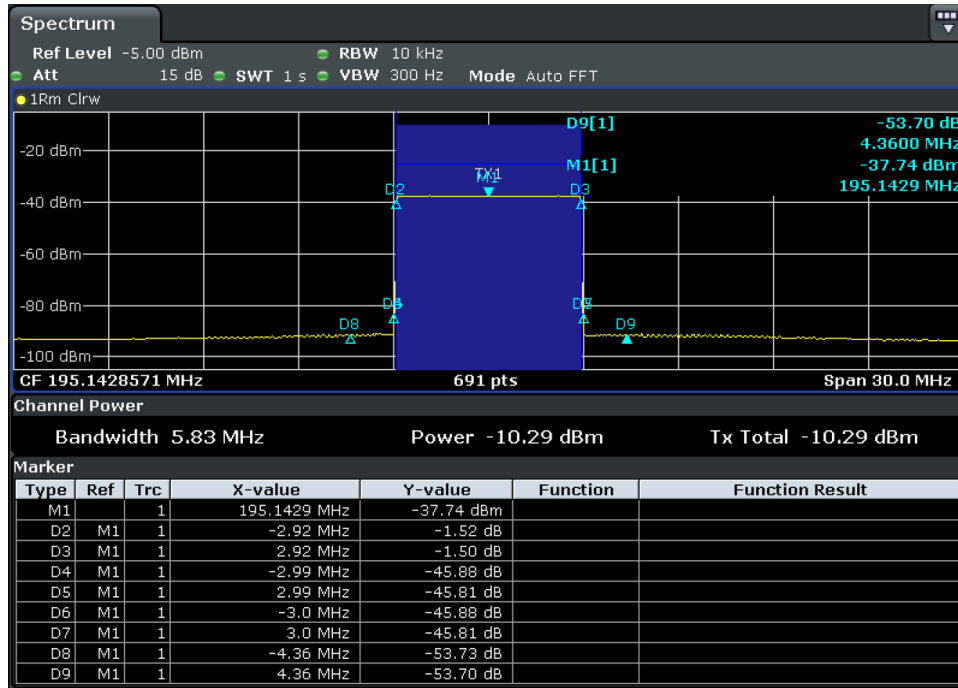
(b)

Figure A 2 - IF Spectrum of Modulator A (a) Horizontal Polarization, (b) Vertical Polarization

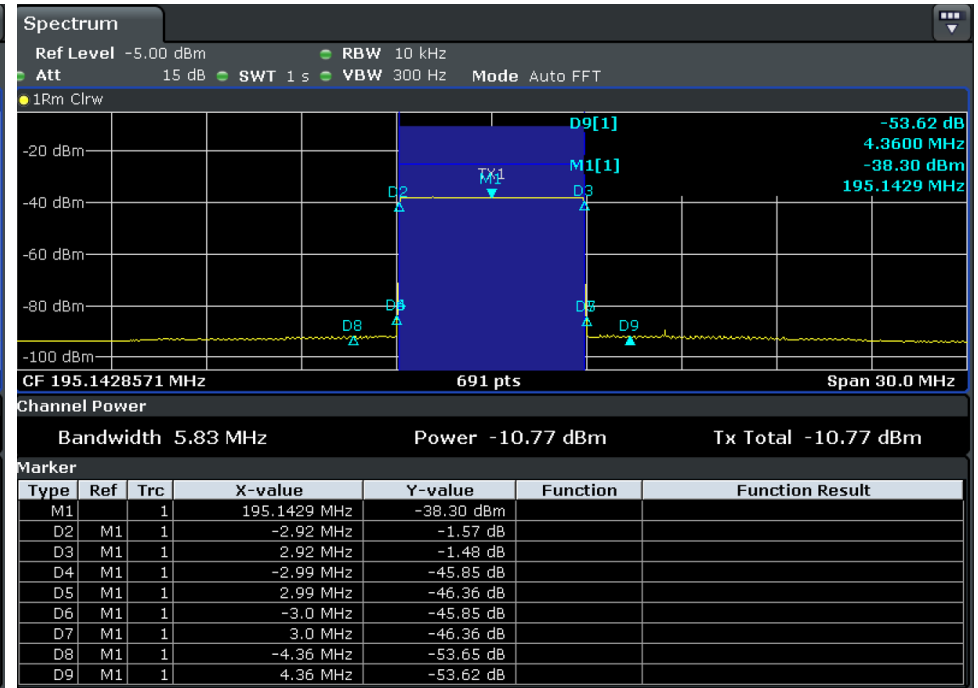


**Table A 7 - IF MASK for Config 1 - Modulator A**

IF M1 = 37.15 MHz			Horizontal		Vertical	
Marker Name	Delta Frequency (MHz)	Theoretical (dB)	Delta Value (dB)	Result	Delta Value (dB)	Result
D2	M1 - 2.92	≤ 0	- 1.43	OK	- 1.56	OK
D3	M1 + 2.92	≤ 0	- 1.35	OK	- 1.27	OK
D4	M1 - 2.99	≤ - 20	- 46.33	OK	- 47.46	OK
D5	M1 + 2.99	≤ - 20	- 46.79	OK	- 46.05	OK
D6	M1 - 3.00	≤ - 27	- 46.33	OK	- 47.46	OK
D7	M1 + 3.00	≤ - 27	- 46.79	OK	- 46.05	OK
D8	M1 - 4.36	≤ - 50	- 56.66	OK	- 56.62	OK
D9	M1 + 4.36	≤ - 50	- 56.17	OK	- 56.37	OK



(a)

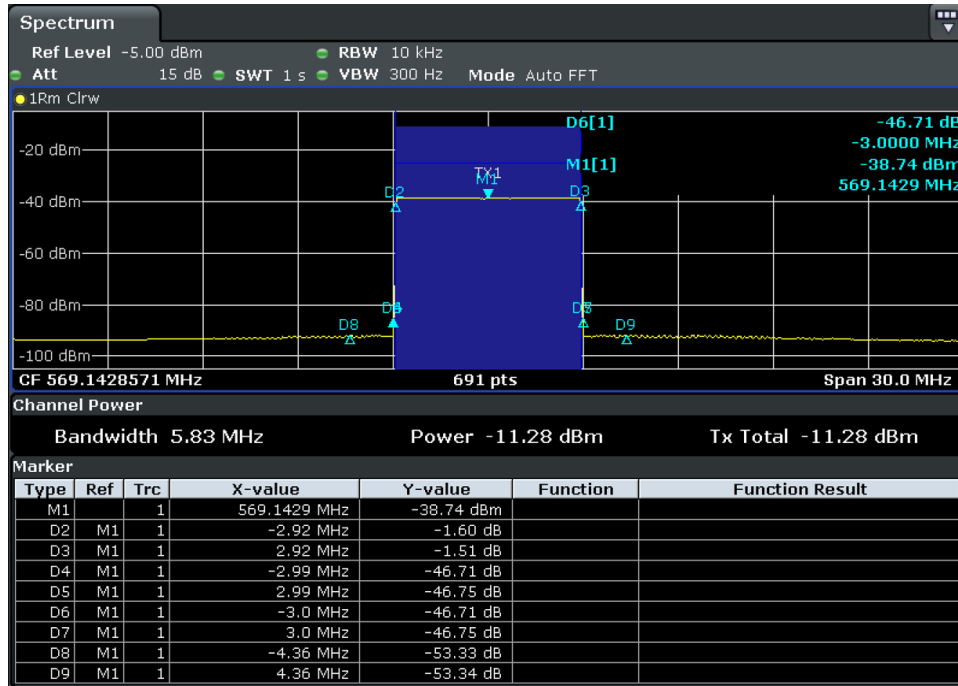


(b)

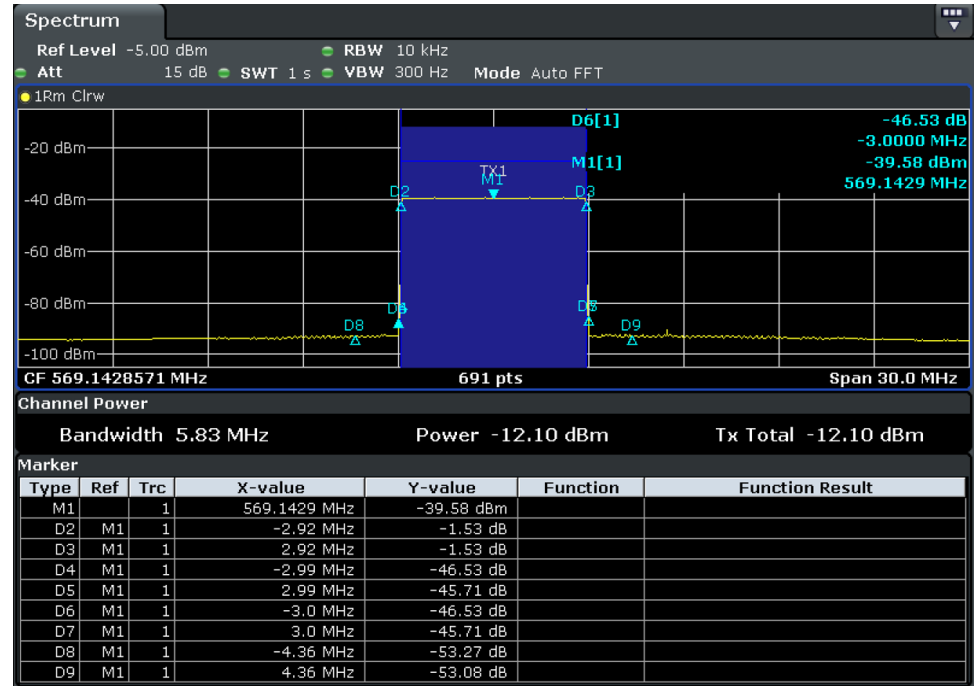
Figure A 3 - CH10 Spectrum of Modulator A (a) Horizontal Polarization, (b) Vertical Polarization

Table A 8 - CH10 MASK for Config 1 - Modulator A

CH10 M1 = 195.142857 MHz			Horizontal		Vertical	
Marker Name	Delta Frequency (MHz)	Theoretical (dB)	Delta Value (dB)	Result	Delta Value (dB)	Result
D2	M1 - 2.92	$\leq 0$	- 1.52	OK	- 1.57	OK
D3	M1 + 2.92	$\leq 0$	- 1.50	OK	- 1.48	OK
D4	M1 - 2.99	$\leq - 20$	- 45.88	OK	- 45.85	OK
D5	M1 + 2.99	$\leq - 20$	- 45.81	OK	- 46.36	OK
D6	M1 - 3.00	$\leq - 27$	- 45.88	OK	- 45.85	OK
D7	M1 + 3.00	$\leq - 27$	- 45.81	OK	- 46.36	OK
D8	M1 - 4.36	$\leq - 50$	- 53.73	OK	- 53.65	OK
D9	M1 + 4.36	$\leq - 50$	- 53.70	OK	- 53.62	OK



(a)

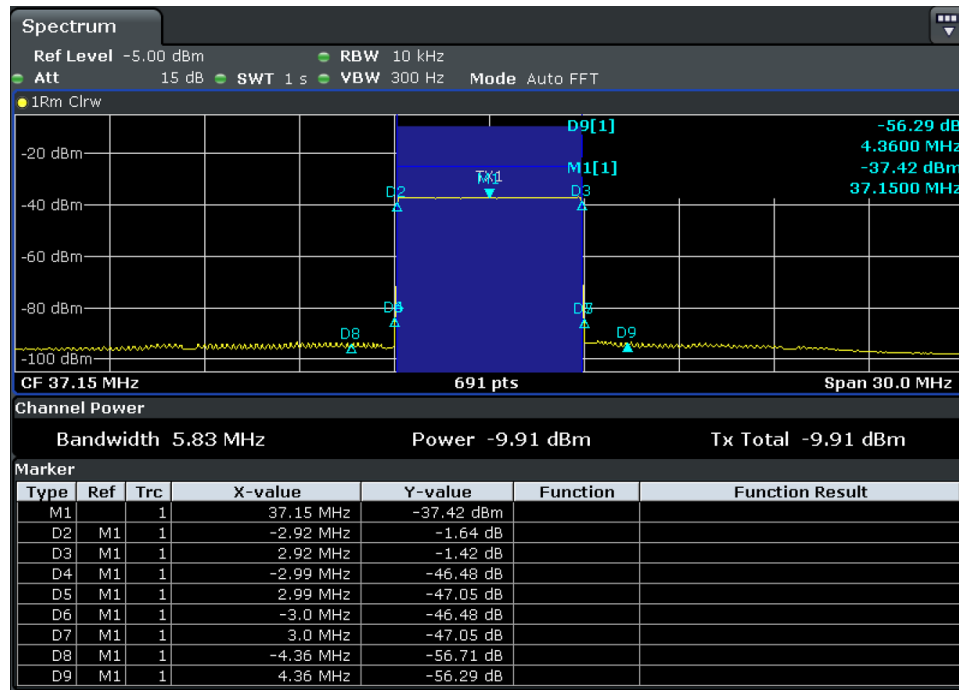


(b)

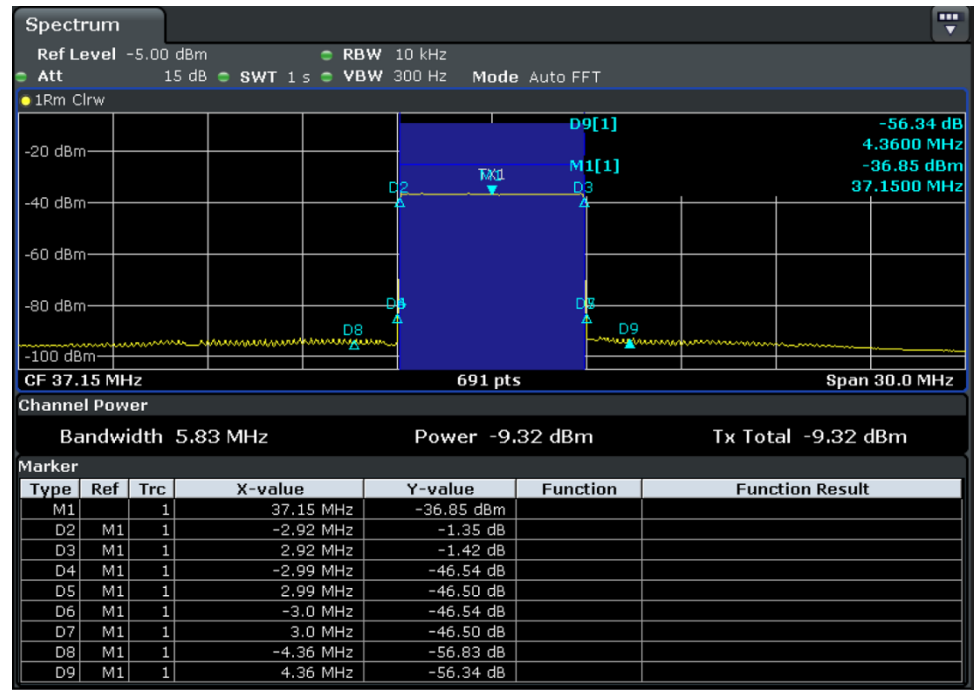
Figure A 4 - CH30 Spectrum of Modulator A (a) Horizontal Polarization, (b) Vertical Polarization

Table A 9 - CH30 MASK for Config 1 - Modulator A

CH30 M1 = 569.142857 MHz			Horizontal		Vertical	
Marker Name	Delta Frequency (MHz)	Theoretical (dB)	Delta Value (dB)	Result	Delta Value (dB)	Result
D2	M1 - 2.92	≤ 0	- 1.60	OK	- 1.53	OK
D3	M1 + 2.92	≤ 0	- 1.51	OK	- 1.53	OK
D4	M1 - 2.99	≤ - 20	- 46.71	OK	- 46.53	OK
D5	M1 + 2.99	≤ - 20	- 46.75	OK	- 45.71	OK
D6	M1 - 3.00	≤ - 27	- 46.71	OK	- 46.53	OK
D7	M1 + 3.00	≤ - 27	- 46.75	OK	- 45.71	OK
D8	M1 - 4.36	≤ - 50	- 53.33	OK	- 53.27	OK
D9	M1 + 4.36	≤ - 50	- 53.34	OK	- 53.08	OK



(a)

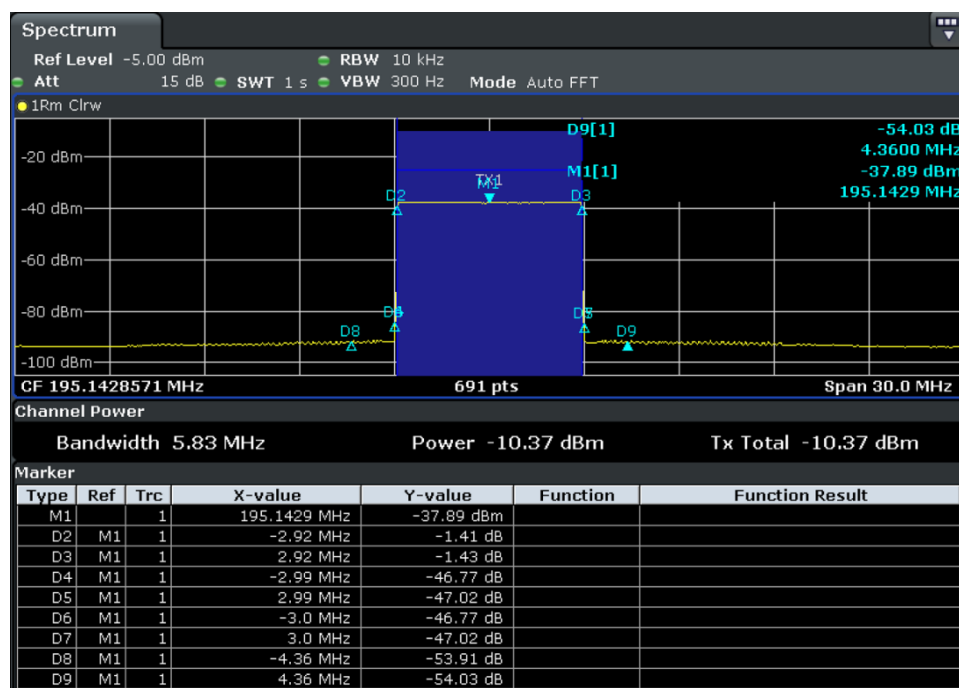


(b)

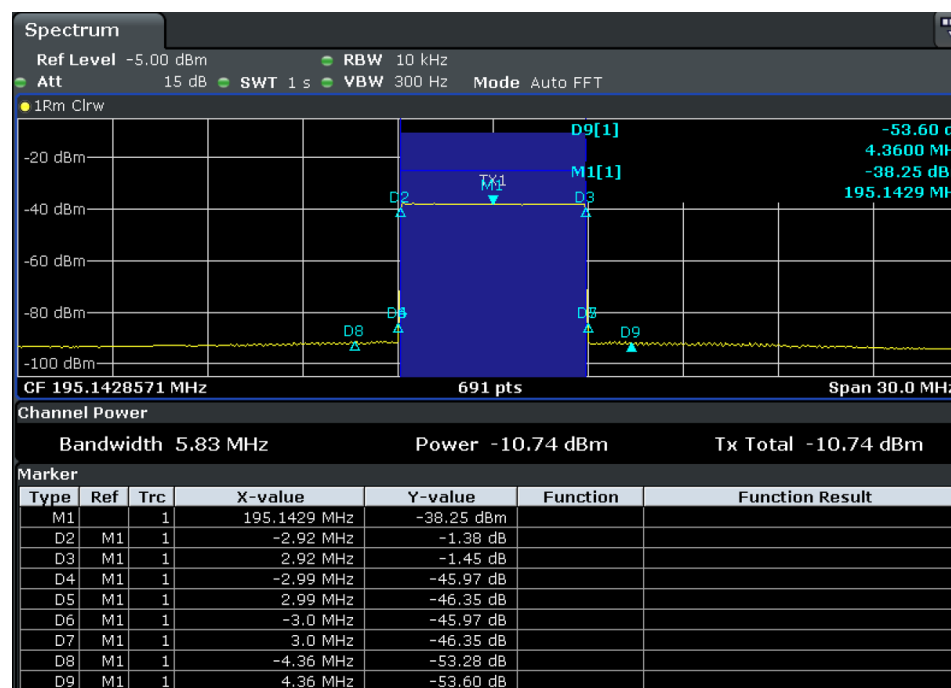
Figure A 5 - IF Spectrum of Modulator B (a) Horizontal Polarization, (b) Vertical Polarization

Table A 10 - IF MASK for Config 1 - Modulator B

IF M1 = 37.15 MHz			Horizontal		Vertical	
Marker Name	Delta Frequency (MHz)	Theoretical (dB)	Delta Value (dB)	Result	Delta Value (dB)	Result
D2	M1 - 2.92	≤ 0	- 1.64	OK	- 1.35	OK
D3	M1 + 2.92	≤ 0	- 1.42	OK	- 1.42	OK
D4	M1 - 2.99	≤ - 20	- 46.48	OK	- 46.54	OK
D5	M1 + 2.99	≤ - 20	- 47.05	OK	- 46.50	OK
D6	M1 - 3.00	≤ - 27	- 46.48	OK	- 46.54	OK
D7	M1 + 3.00	≤ - 27	- 47.05	OK	- 46.50	OK
D8	M1 - 4.36	≤ - 50	- 56.71	OK	- 56.83	OK
D9	M1 + 4.36	≤ - 50	- 56.29	OK	- 56.34	OK



(a)



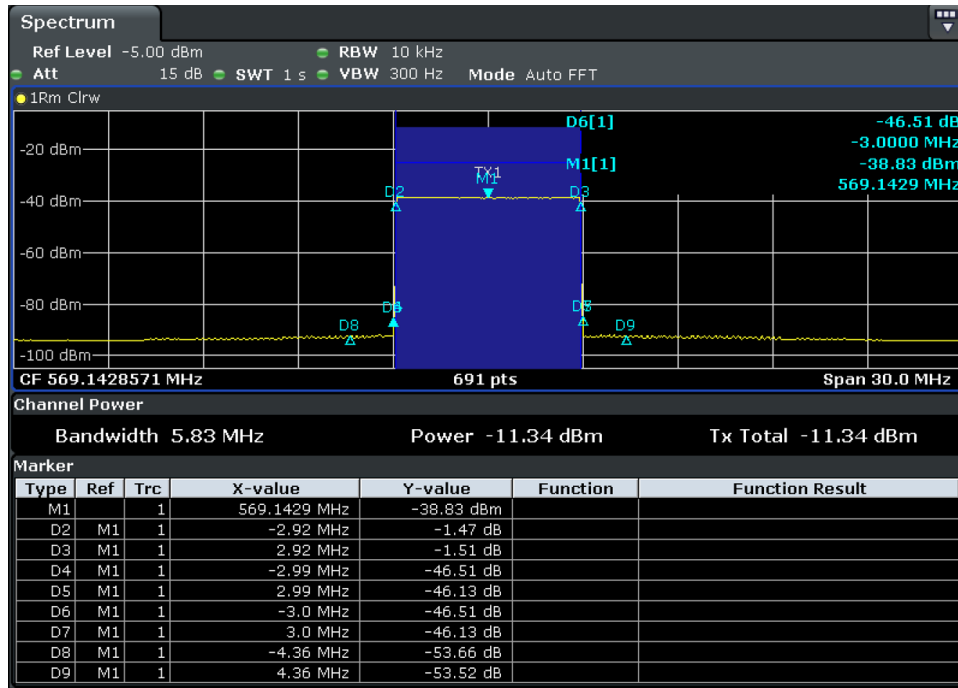
(b)

Figure A 6 - CH10 Spectrum of Modulator B (a) Horizontal Polarization, (b) Vertical Polarization

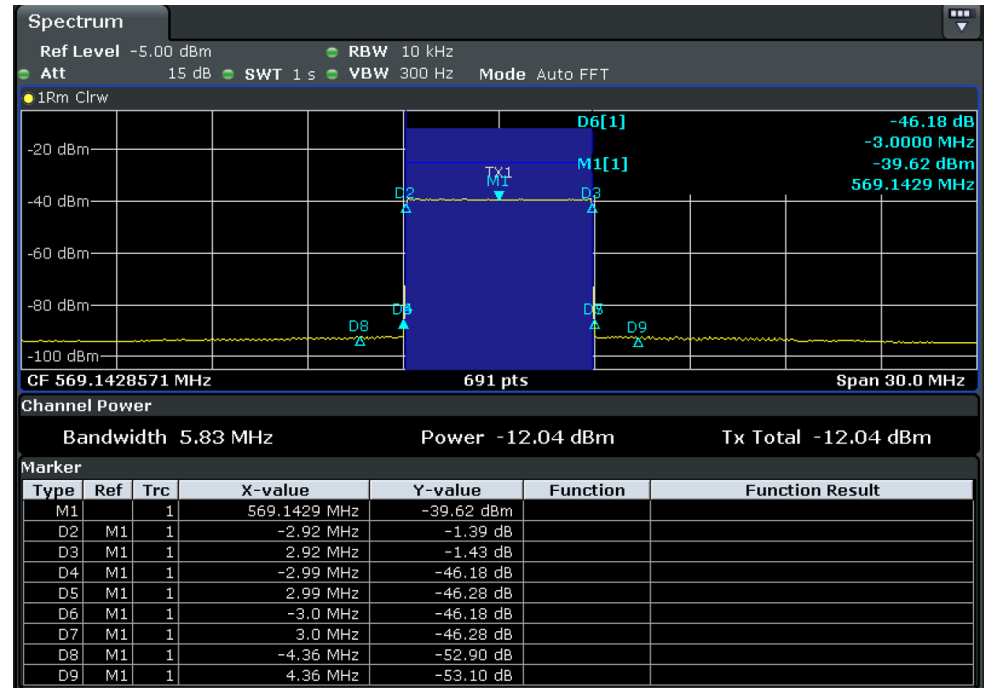
Table A 11 - CH10 MASK for Config 1 - Modulator B

CH10 M1 = 195.142857 MHz			Horizontal		Vertical	
Marker Name	Delta Frequency (MHz)	Theoretical (dB)	Delta Value (dB)	Result	Delta Value (dB)	Result
D2	M1 - 2.92	≤ 0	- 1.41	OK	- 1.38	OK
D3	M1 + 2.92	≤ 0	- 1.43	OK	- 1.45	OK
D4	M1 - 2.99	≤ - 20	- 46.77	OK	- 45.97	OK
D5	M1 + 2.99	≤ - 20	- 47.02	OK	- 46.35	OK
D6	M1 - 3.00	≤ - 27	- 46.77	OK	- 45.97	OK
D7	M1 + 3.00	≤ - 27	- 47.02	OK	- 46.35	OK
D8	M1 - 4.36	≤ - 50	- 53.91	OK	- 53.28	OK
D9	M1 + 4.36	≤ - 50	- 54.03	OK	- 53.60	OK





(a)



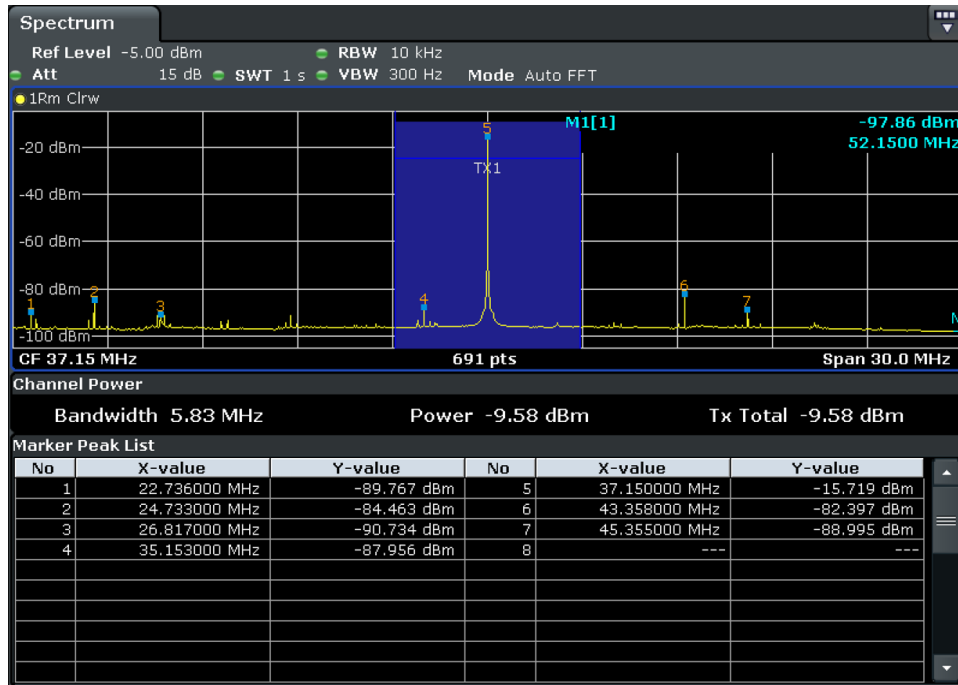
(b)

Figure A 7 - CH30 Spectrum of Modulator B (a) Horizontal Polarization, (b) Vertical Polarization

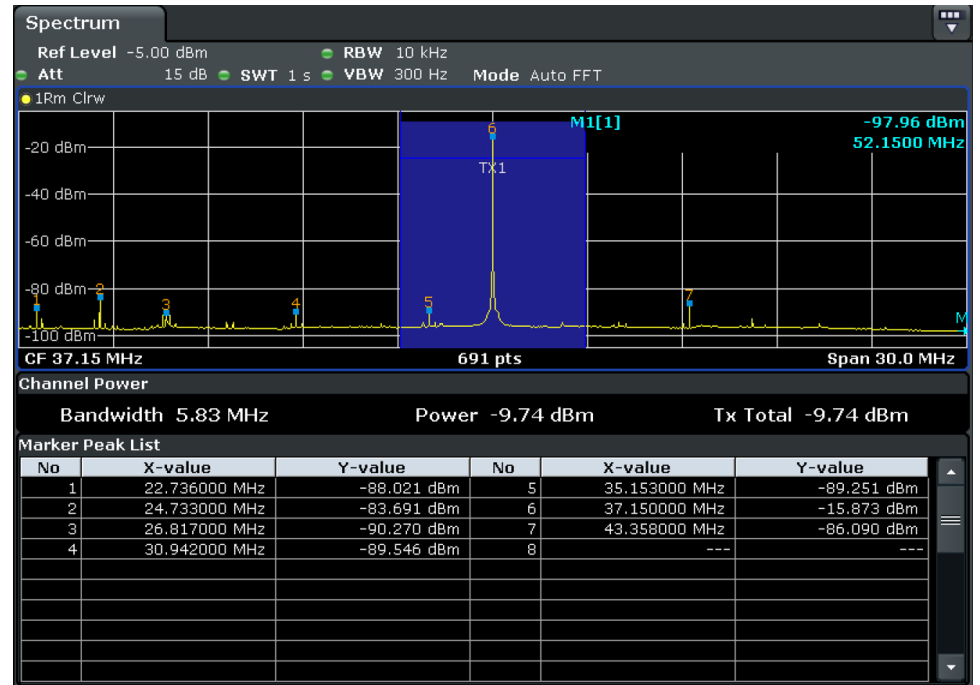
**Table A 12 - CH30 MASK for Config 1 - Modulator B**

CH30 M1 = 569.142857 MHz			Horizontal		Vertical	
Marker Name	Delta Frequency (MHz)	Theoretical (dB)	Delta Value (dB)	Result	Delta Value (dB)	Result
D2	M1 - 2.92	≤ 0	- 1.47	OK	- 1.39	OK
D3	M1 + 2.92	≤ 0	- 1.51	OK	- 1.43	OK
D4	M1 - 2.99	≤ - 20	- 46.51	OK	- 46.18	OK
D5	M1 + 2.99	≤ - 20	- 46.13	OK	- 46.28	OK
D6	M1 - 3.00	≤ - 27	- 46.51	OK	- 46.18	OK
D7	M1 + 3.00	≤ - 27	- 46.13	OK	- 46.28	OK
D8	M1 - 4.36	≤ - 50	- 53.66	OK	- 52.90	OK
D9	M1 + 4.36	≤ - 50	- 53.52	OK	- 53.10	OK

The RF Out-of-Band Emissions were measured, following the procedure established in Section 4.2.3.1.4 of the “TV 3.0 CfP Phase 2 / Testing and Evaluation” document, at the output of the Up Converter submitted by the proponent. The Up Converter input was connected to the Advanced ISDB-T Modulator IF Output, which was configured to output a CW signal. The results for Modulator A are presented in Figure A 8 to Figure A 10 and for Modulator B in Figure A 11 to Figure A 13.

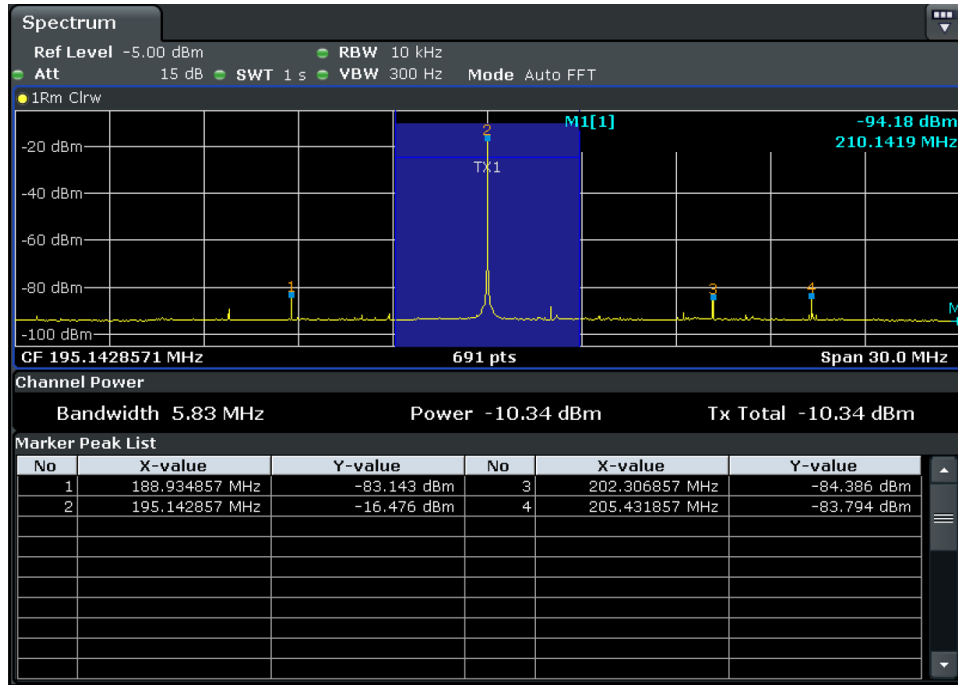


(a)

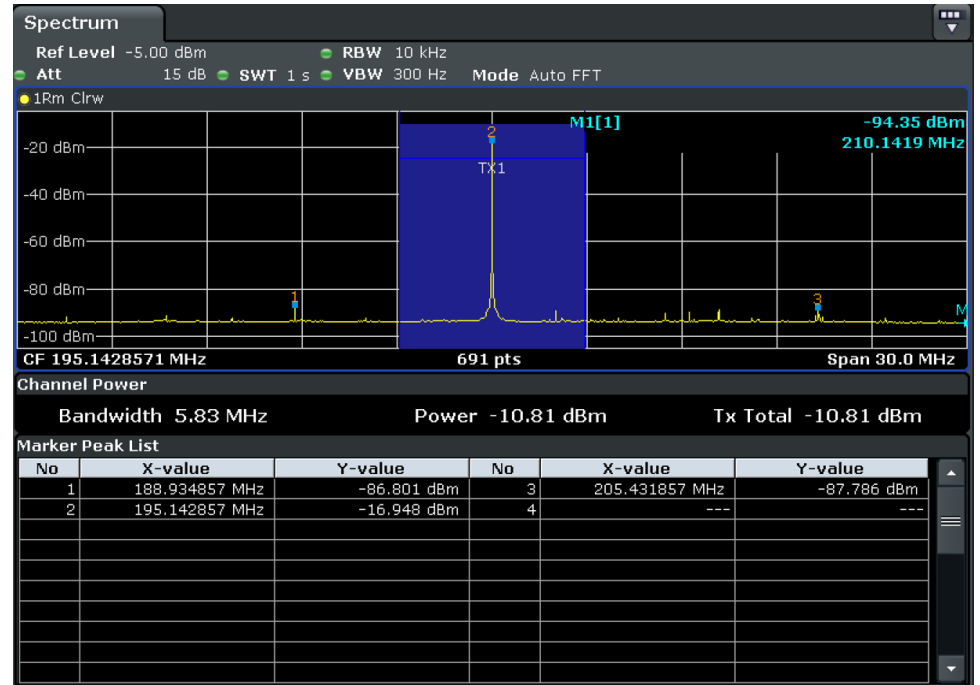


(b)

Figure A 8 - IF Out-of-Band Emissions of Modulator A (a) Horizontal Polarization, (b) Vertical Polarization

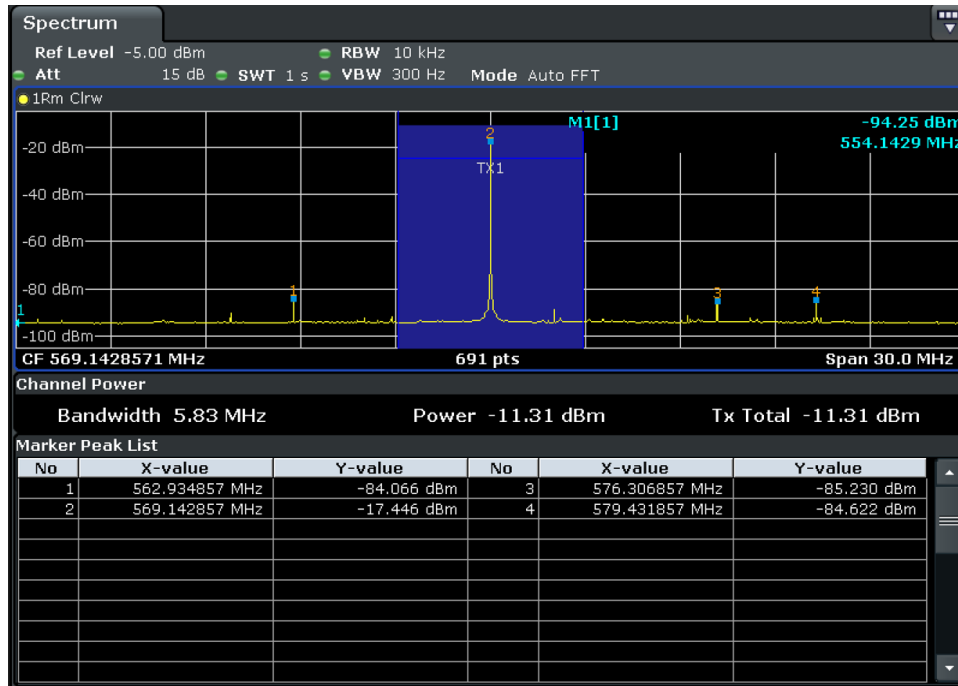


(a)

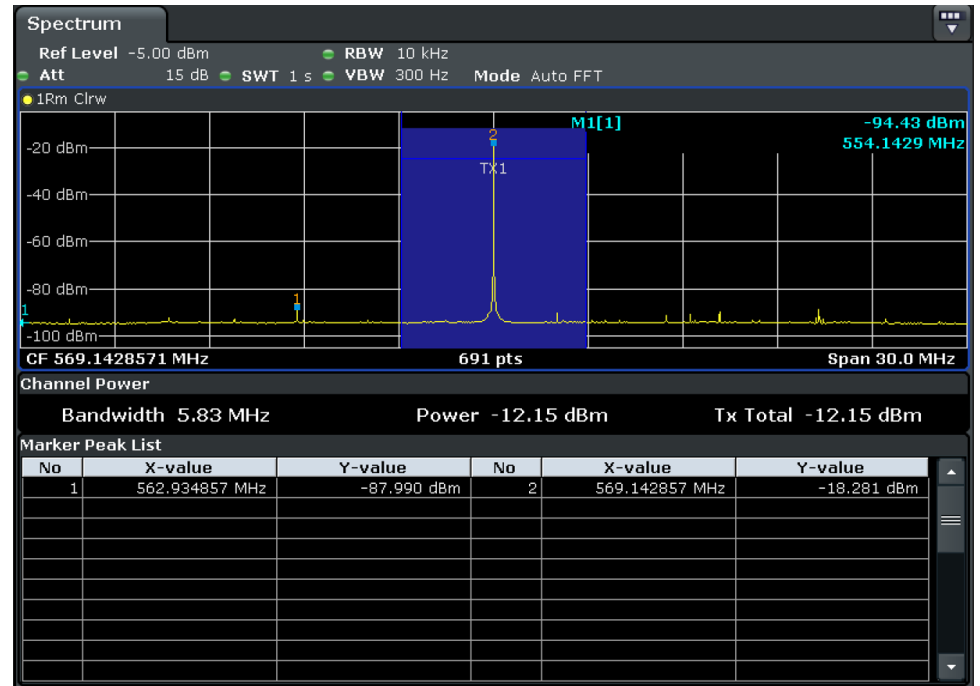


(b)

Figure A 9 - CH10 Out-of-Band Emissions of Modulator A (a) Horizontal Polarization, (b) Vertical Polarization

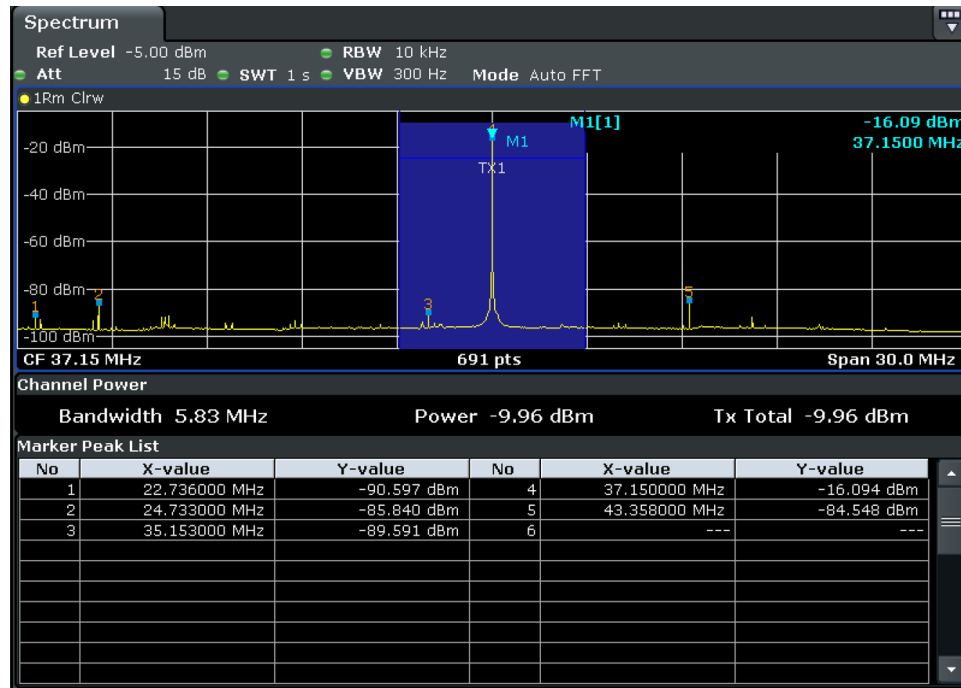


(a)

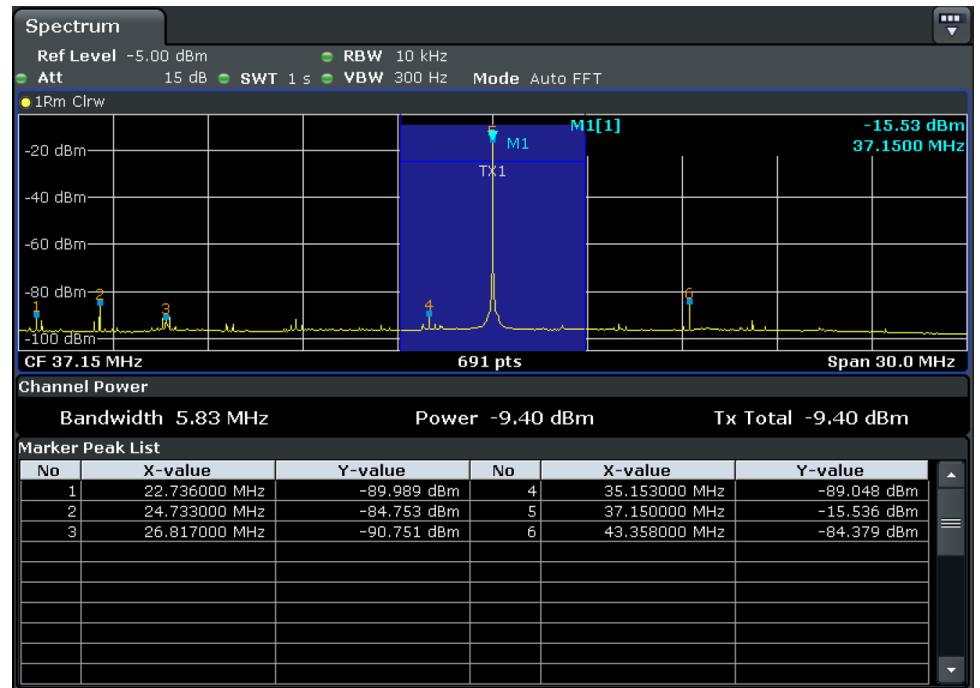


(b)

Figure A 10 - CH30 Out-of-Band Emissions of Modulator A (a) Horizontal Polarization, (b) Vertical Polarization

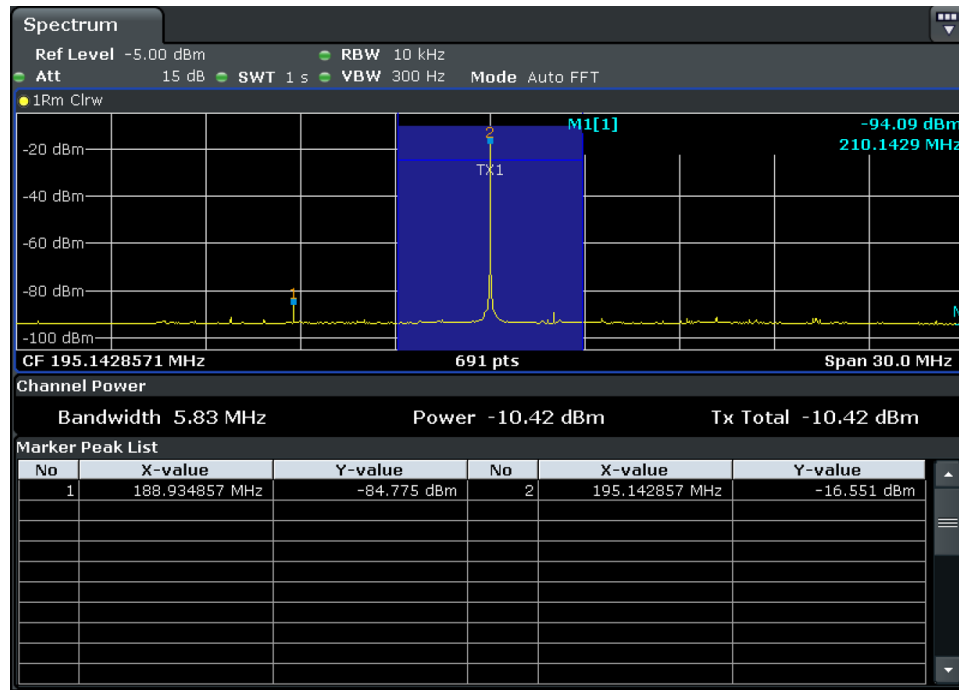


(a)

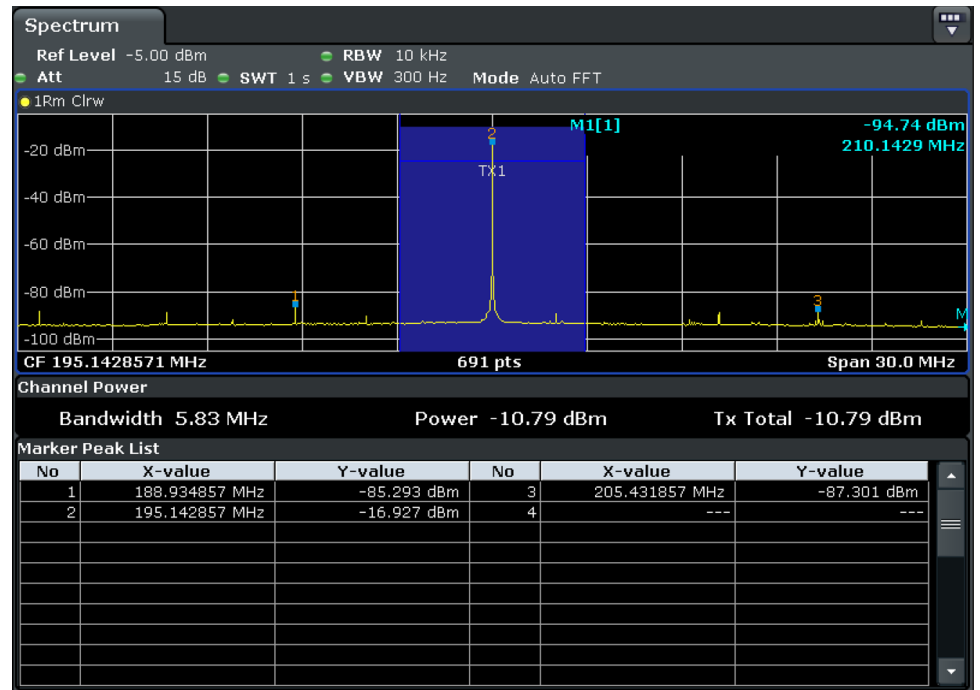


(b)

Figure A 11 - IF Out-of-Band Emissions of Modulator B (a) Horizontal Polarization, (b) Vertical Polarization

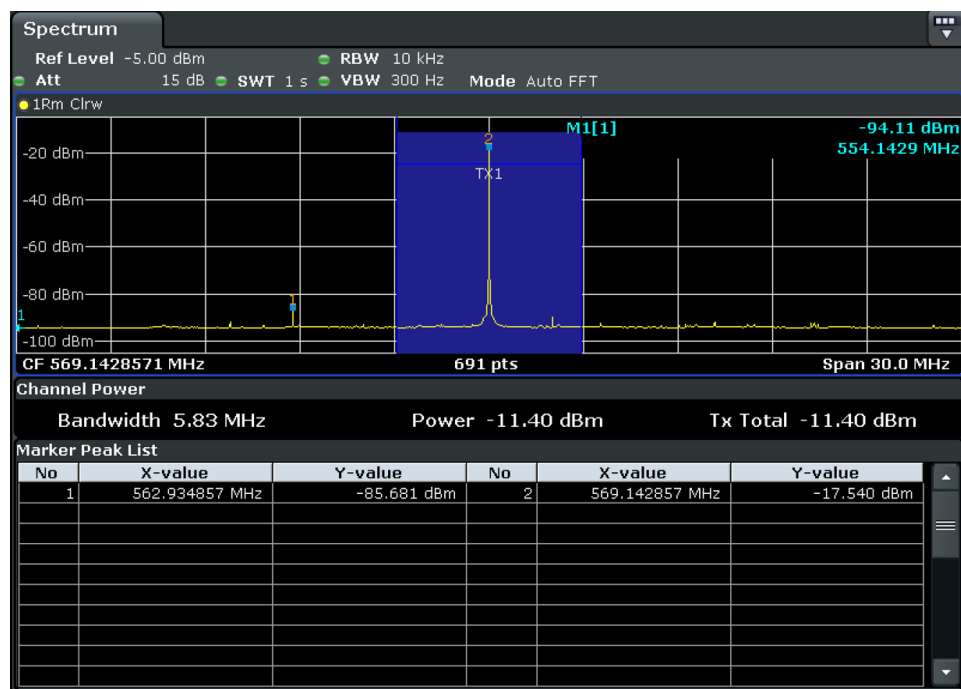


(a)

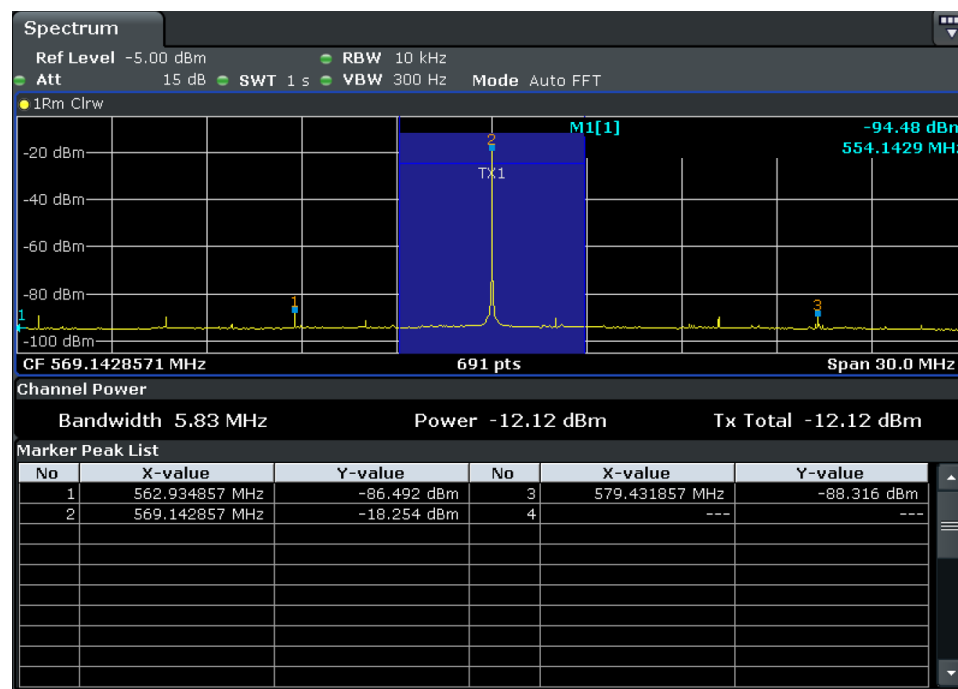


(b)

Figure A 12 - CH10 Out-of-Band Emissions of Modulator B (a) Horizontal Polarization, (b) Vertical Polarization



(a)



(b)

Figure A 13 - CH30 Out-of-Band Emissions of Modulator B (a) Horizontal Polarization, (b) Vertical Polarization

### 6.2.2.1.1.5 I/Q analysis – Constellation and MER

The I/Q Analysis – Constellation and MER were measured, following the procedure established in Section 4.2.3.1.5 of the “TV 3.0 CfP Phase 2 / Testing and Evaluation” document. The demodulator provided by the proponent can measure the Constellation and MER. The MER results are presented in the Table A 13 and Table A 14 and constellations in Figure A 14 to Figure A 21.



**Table A 13 - MER for Config 1**

MER (dB)	Config 1		
	Polarization	CH10	CH30
Modulator/ Demodulator A	H1	35.15	35.15
	V1	35.71	35.15
Modulator/ Demodulator B	H1	35.15	35.15
	V1	35.15	35.71

**Table A 14 - MER for Config 2**

MER (dB)		Config 2			
		CH10		CH30	
		LA	LB	LA	LB
Modulator/ Demodulator A	H1	35.15	35.15	35.15	35.15
	V1	36.12	35.91	35.15	35.15
Modulator/ Demodulator B	H1	35.15	35.15	35.15	35.15
	V1	36.12	35.61	35.52	35.71

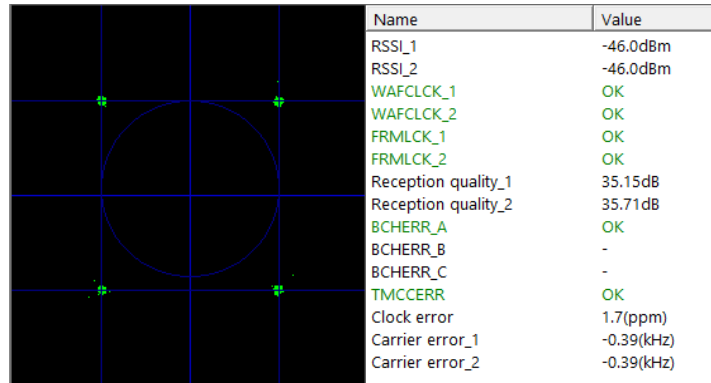


Figure A 14 - CH10 Constellation of Modulator/Demodulator A for Config 1

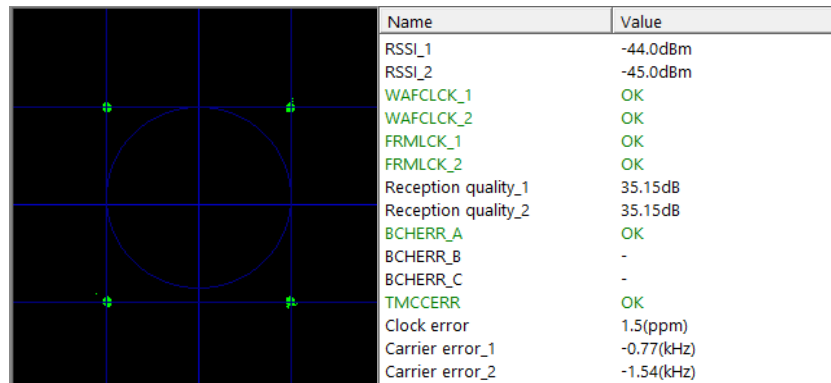


Figure A 15 - CH30 Constellation of Modulator/Demodulator A for Config 1

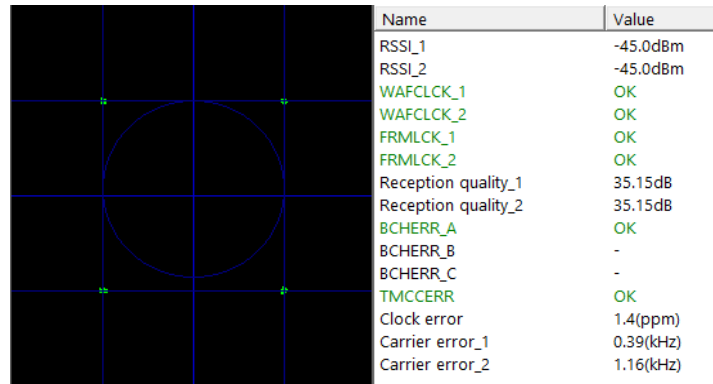


Figure A 16 - CH10 Constellation of Modulator/Demodulator B for Config 1

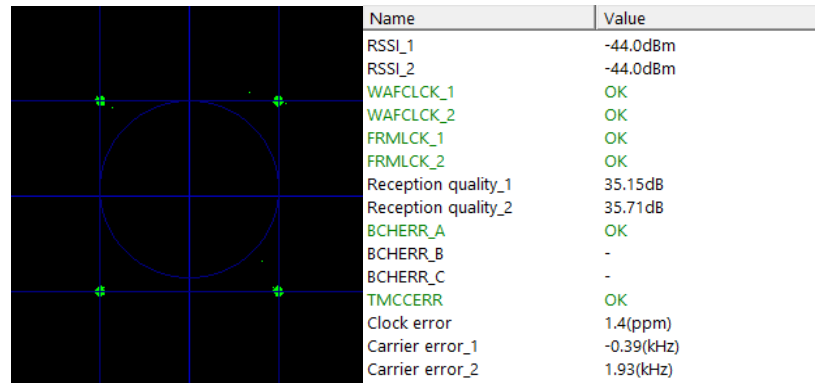
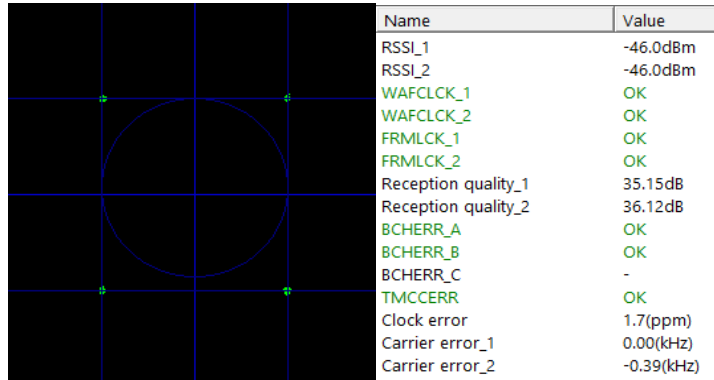
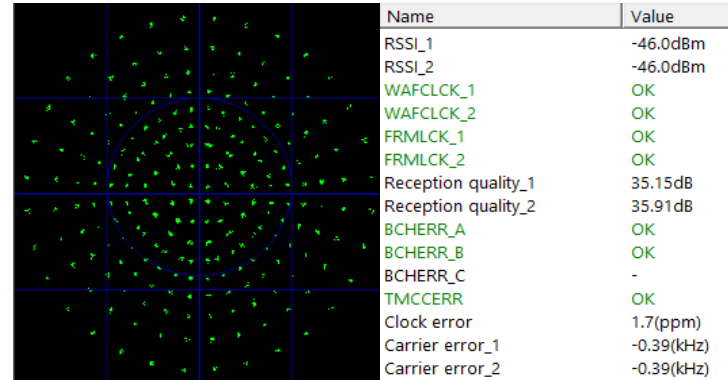


Figure A 17 - CH30 Constellation of Modulator/Demodulator B for Config 1

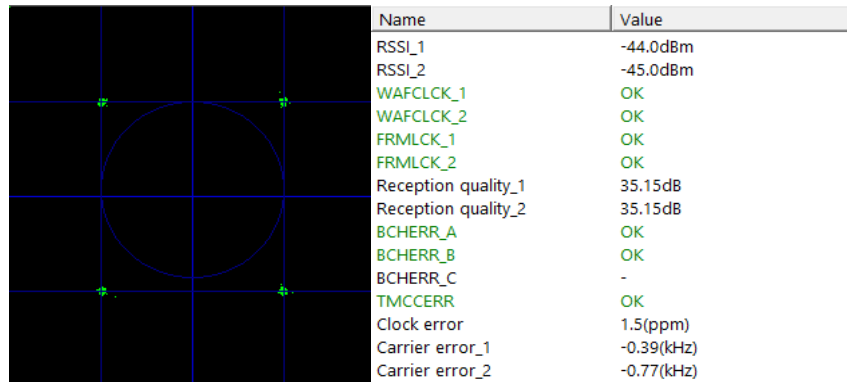


(a)

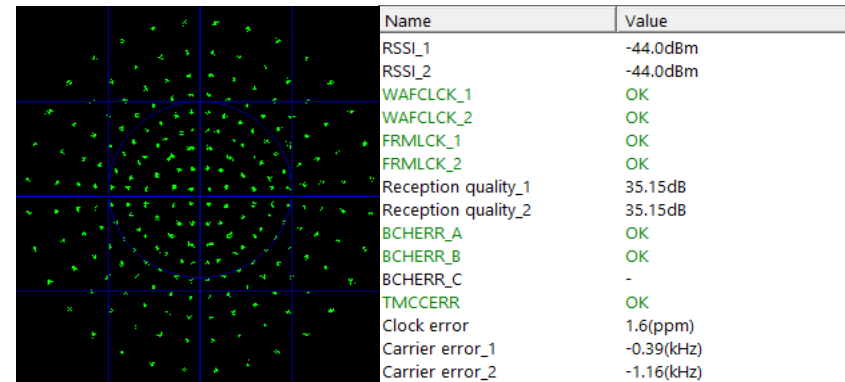


(b)

Figure A 18 - CH10 Constellation of Modulator/Demodulator A for Config 2 (a) Layer A, (b) Layer B

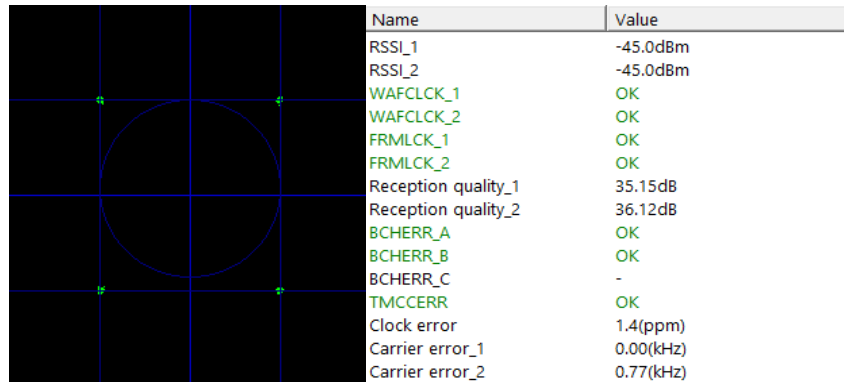


(a)

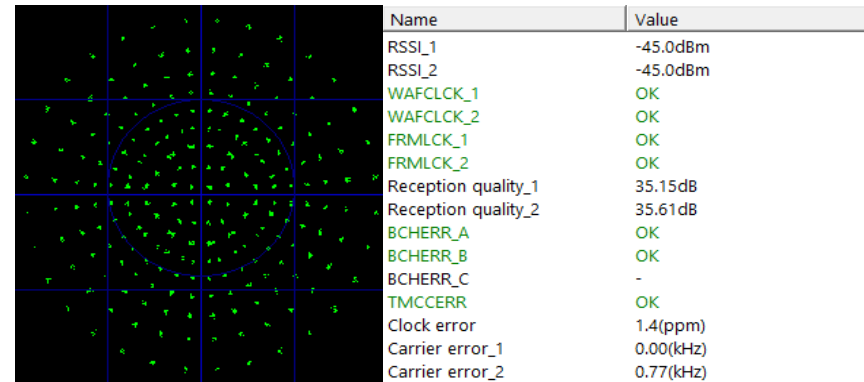


(b)

Figure A 19 - CH30 Constellation of Modulator/Demodulator A for Config 2 (a) Layer A, (b) Layer B

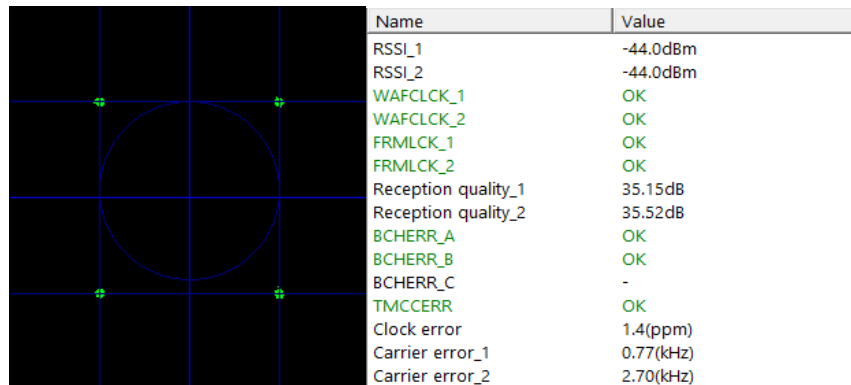


(a)

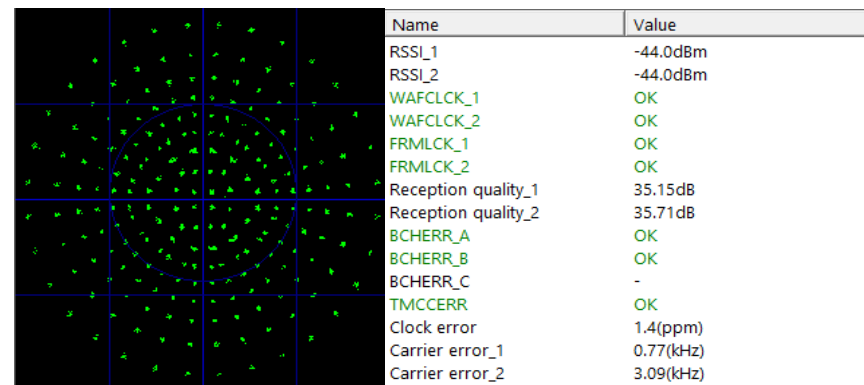


(b)

Figure A 20 - CH10 Constellation of Modulator/Demodulator B for Config 2 (a) Layer A, (b) Layer B



(a)



(b)

Figure A 21 - CH30 Constellation of Modulator/Demodulator B for Config 2 (a) Layer A, (b) Layer B

### 6.2.2.1.2 Evaluation Tests

The Verifications Tests presented results that allowed us to proceed to the Evaluation Tests. All tests are done with MIMO configuration.

#### 6.2.2.1.2.1 C/N - Carrier power vs AWGN

The C/N tests over AWGN channel results are present below and follow the test procedure described in Section 4.2.3.2.1 of Phase 2 document and the results are presented in Table A 15 and

Table A 16.

**Table A 15 - C/N over AWGN for Single Layer**

Config/CH	Results			
	C/N (dB)			
	C = - 28 dBm	C = - 53 dBm	C = - 68 dBm	C = - 83 dBm
Config 1 (CH10)	- 1.6	- 0.6	- 0.6	- 0.6
Config 1 (CH30)	- 1.5	- 0.6	- 0.6	- 0.6
Config 5 (CH10)	- 0.6	- 0.6	- 0.6	- 0.5
Config 5 (CH30)	- 0.6	- 0.5	- 0.6	- 0.5
Config 10 (CH30)	17.6	17.6	17.7	Failed
Config 11 (CH30)	14.9	14.6	14.7	Failed

**Table A 16 - C/N over AWGN for Dual Layer**

CH	Config 9							
	C/N (dB)							
	C = - 28 dBm		C = - 53 dBm		C = - 68 dBm		C = - 83 dBm	
	LA	LB	LA	LB	LA	LB	LA	LB
10	- 0.5	14.7	- 0.5	14.7	- 0.6	14.8	- 0.5	16.3
30	- 0.6	14.7	- 0.5	14.7	- 0.6	14.8	- 0.5	18.2

#### 6.2.2.1.2.2 C/N - Carrier power vs Noise Power over Rayleigh and AWGN Channels

The C/N over Rayleigh and AWGN channel was conducted according to Section 5.2.1, including the fading parameters. The results are presented in Table A 17 to

Table A 28.

**Table A 17 - C/N over Rayleigh Ensemble RF1 for Single Layer**

Config/CH	Results							
	C/N (dB)							
	C = - 28 dBm		C = - 53 dBm		C = - 68 dBm		C = - 83 dBm	
Speed (Km/h)	0	3	0	3	0	3	0	3
Config 1 (CH10)	-1.5	-1.5	-1.5	-1.5	-1.5	-1.5	-1.5	-1.5
Config 1 (CH30)	-1.5	-1.5	-1.5	-1.5	-1.5	-1.5	-1.5	-1.5
Config 5 (CH10)	-0.5	-0.5	-0.5	-0.5	-0.5	-0.5	-0.5	-0.5
Config 5 (CH30)	-0.6	-0.6	-0.6	-0.6	-0.6	-0.6	-0.5	-0.5
Config 10 (CH30)	17.6	17.6	17.6	17.6	17.7	17.7	Failed	Failed
Config 11 (CH30)	14.6	14.7	15	14.7	15	14.8	17.8	17.8

**Table A 18 - C/N over Rayleigh Ensemble RF1 for Dual Layer**

CH	Config 9															
	C/N (dB)															
	C = - 28 dBm				C = - 53 dBm				C = - 68 dBm				C = - 83 dBm			
	LA		LB		LA		LB		LA		LB		LA		LB	
Speed (Km/h)	0	3	0	3	0	3	0	3	0	3	0	3	0	3	0	3
10	-0.6	-0.6	15	14.8	-0.5	-0.5	14.8	14.8	-0.5	-0.6	14.8	14.8	-0.5	-0.5	14.8	17.4
30	-0.6	-0.6	15	14.7	-0.6	-0.6	14.7	14.7	-0.6	-0.5	14.8	14.8	-0.5	-0.5	17.9	17.3

**Table A 19 - C/N over Rayleigh Ensemble RF2A for Single Layer**

Config/CH	Results							
	C/N (dB)							
	C = - 28 dBm		C = - 53 dBm		C = - 68 dBm		C = - 83 dBm	
Speed (Km/h)	0	3	0	3	0	3	0	3
Config 1 (CH10)	-1	6.0	-1	5.5	-1	5.5	-1	5.8
Config 1 (CH30)	-1	2.8	-1	3.0	-1	2.9	-1	3.4
Config 5 (CH10)	0	10.0	0	10.5	0	10.5	0.1	10.8
Config 5 (CH30)	0	9.2	0	8.8	0	8.4	0.1	8.6
Config 10 (CH30)	18.1	Failed	18.2	Failed	19.2	Failed	Failed	Failed
Config 11 (CH30)	15.2	Failed	15.5	Failed	15.7	Failed	Failed	Failed

**Table A 20 - C/N over Rayleigh Ensemble RF2A for Dual Layer**

CH	Config 9															
	C/N (dB)															
	C = - 28 dBm				C = - 53 dBm				C = - 68 dBm				C = - 83 dBm			
	LA		LB		LA		LB		LA		LB		LA		LB	
Speed (Km/h)	0	3	0	3	0	3	0	3	0	3	0	3	0	3	0	3
10	0	6	15.3	Failed	0	6.1	15.4	Failed	0	6.1	15.4	Failed	0.1	6.1	17.3	Failed
30	0	4.0	15.3	20.3	0	3.9	15.3	20.2	0	3.9	15.4	21.3	0.1	4.6	19.5	Failed

**Table A 21 - C/N over Rayleigh Ensemble RF2B for Single Layer**

Config/CH	Results							
	C/N (dB)							
	C = - 28 dBm		C = - 53 dBm		C = - 68 dBm		C = - 83 dBm	
Speed (Km/h)	0	3	0	3	0	3	0	3
Config 1 (CH10)	-0.3	4.5	-0.3	4.1	-0.3	4.2	-0.3	4.3
Config 1 (CH30)	-0.3	3.3	-0.3	3.3	-0.3	3.3	-0.3	3.4
Config 5 (CH10)	1	5.3	1	5.6	1	5.9	1	5.7
Config 5 (CH30)	1	5.0	1	5.0	1	4.6	1	5.0
Config 10 (CH30)	22	Failed	22.1	Failed	24.6	Failed	Failed	Failed
Config 11 (CH30)	18.9	Failed	19	Failed	19.9	Failed	Failed	Failed

**Table A 22 - C/N over Rayleigh Ensemble RF2B for Dual Layer**

CH	Config 9															
	C/N (dB)															
	C = - 28 dBm				C = - 53 dBm				C = - 68 dBm				C = - 83 dBm			
	LA		LB		LA		LB		LA		LB		LA		LB	
Speed (Km/h)	0	3	0	3	0	3	0	3	0	3	0	3	0	3	0	3
10	0.6	5.5	17.1	Failed	0.6	5.0	17.5	Failed	0.6	5.4	17.2	Failed	0.7	5.0	20.4	Failed
30	0.6	5	17.1	23.3	0.6	4.9	17.1	23.9	0.6	4.7	17.2	25.6	0.7	5	27	Failed



**Table A 23 - C/N over Rayleigh Ensemble RF3A for Single Layer**

Config/CH	Results											
	C/N (dB)											
	C = - 28 dBm			C = - 53 dBm			C = - 68 dBm			C = - 83 dBm		
Speed (Km/h)	0	50	120	0	50	120	0	50	120	0	50	120
Config 1 (CH10)	0	1.4	0.9	0	1.2	1	-0.1	1.4	0.8	0	1.3	1
Config 1 (CH30)	-0.1	1.0	Failed	0	1.0	Failed	-0.1	1.0	Failed	0	1.0	Failed
Config 5 (CH10)	1.3	2.5	3.4	1.3	2.8	2.8	1.4	2.8	3.1	1.4	2.8	3.1
Config 5 (CH30)	1.2	2.2	Failed	1.2	2.2	Failed	1.2	2.2	Failed	1.3	2.3	Failed
Config 10 (CH30)	25.9	Failed	Failed	26	Failed	Failed	Failed	Failed	Failed	Failed	Failed	Failed
Config 11 (CH30)	22.7	Failed	Failed	22.8	Failed	Failed	25.7	Failed	Failed	Failed	Failed	Failed

**Table A 24 - C/N over Rayleigh Ensemble RF3A for Dual Layer**

CH	Config 9																							
	C/N (dB)																							
	C = - 28 dBm						C = - 53 dBm						C = - 68 dBm						C = - 83 dBm					
	LA			LB			LA			LB			LA			LB			LA			LB		
Speed (Km/h)	0	50	120	0	50	120	0	50	120	0	50	120	0	50	120	0	50	120	0	50	120	0	50	120
10	0.5	2.5	2.5	18.4	24.4	Failed	0.6	2.5	2.5	18.5	24.4	Failed	0.6	2.6	2.5	18.5	24.2	Failed	0.7	2.8	2.5	18.5	Failed	Failed
30	0.5	2.5	Failed	18.5	Failed	Failed	0.5	2.3	Failed	18.4	Failed	Failed	0.5	2.4	Failed	18.6	Failed	Failed	2	2.4	Failed	24.8	Failed	Failed

**Table A 25 - C/N over Rayleigh Ensemble RF3B for Single Layer**

Config/CH	Results											
	C/N (dB)											
	C = - 28 dBm			C = - 53 dBm			C = - 68 dBm			C = - 83 dBm		
Speed (Km/h)	0	50	120	0	50	120	0	50	120	0	50	120
Config 1 (CH10)	-0.1	1.4	1.1	-0.1	1.5	1.0	-0.1	1.3	1.1	-0.1	1.5	1.1
Config 1 (CH30)	-0.1	1.0	Failed	-0.1	1.0	Failed	-0.1	1.0	Failed	-0.1	1.0	Failed
Config 5 (CH10)	1.2	2.8	2.4	1.2	3	2.5	1.2	3	2.6	1.2	3.2	2.7
Config 5 (CH30)	1.1	2.5	Failed	1.1	2.1	Failed	1.1	2.2	Failed	1.2	2.5	Failed
Config 10 (CH30)	23.2	Failed	Failed	23.2	Failed	Failed	26.8	Failed	Failed	Failed	Failed	Failed
Config 11 (CH30)	20	Failed	Failed	20	Failed	Failed	21.3	Failed	Failed	Failed	Failed	Failed

**Table A 26 - C/N over Rayleigh Ensemble RF3B for Dual Layer**

CH	Config 9																							
	C/N (dB)																							
	C = - 28 dBm						C = - 53 dBm						C = - 68 dBm						C = - 83 dBm					
	LA			LB			LA			LB			LA			LB			LA			LB		
Speed (Km/h)	0	50	120	0	50	120	0	50	120	0	50	120	0	50	120	0	50	120	0	50	120	0	50	120
10	0.5	2.8	2.4	17.4	22.9	Failed	0.6	2.8	2.4	18.5	23.1	Failed	0.6	2.8	2.2	18.5	22.7	Failed	0.7	2.8	2.4	24.8	Failed	Failed
30	0.6	2.5	Failed	17.4	Failed	Failed	0.6	2.6	Failed	17.4	Failed	Failed	0.6	2.5	Failed	17.6	Failed	Failed	0.6	2.6	Failed	31	Failed	Failed

**Table A 27 - C/N over Rayleigh Ensemble RF4 for Single Layer**

Config/CH	Results											
	C/N (dB)											
	C = - 28 dBm			C = - 53 dBm			C = - 68 dBm			C = - 83 dBm		
Speed (Km/h)	0	50	120	0	50	120	0	50	120	0	50	120
Config 1 (CH10)	0	0.8	0.7	0	0.9	0.6	0	0.9	0.7	0.1	1	0.7
Config 1 (CH30)	-0.1	0.8	Failed	0	0.8	Failed	0	0.8	Failed	0.1	0.8	Failed
Config 5 (CH10)	1.3	2.3	2.3	1.3	2.3	2.1	1.3	2.5	1.9	1.4	2.4	2
Config 5 (CH30)	1.2	2.1	Failed	1.2	1.8	Failed	1.2	2	Failed	1.3	2	Failed
Config 10 (CH30)	22.2	Failed	Failed	22.3	Failed	Failed	24.9	Failed	Failed	Failed	Failed	Failed
Config 11 (CH30)	19.4	Failed	Failed	22.3	Failed	Failed	20.6	Failed	Failed	Failed	Failed	Failed

**Table A 28 - C/N over Rayleigh Ensemble RF4 for Dual Layer**

CH	Config 9																							
	C/N (dB)																							
	C = - 28 dBm						C = - 53 dBm						C = - 68 dBm						C = - 83 dBm					
	LA			LB			LA			LB			LA			LB			LA			LB		
Speed (Km/h)	0	50	120	0	50	120	0	50	120	0	50	120	0	50	120	0	50	120	0	50	120	0	50	120
10	1	2.6	2	17.8	21.4	Failed	1.1	2.8	2	17.9	21.5	Failed	1	2.8	2	18	21.5	Failed	1.1	2.9	2	22.3	Failed	Failed
30	0.9	2	Failed	17.8	Failed	Failed	1	2	Failed	17.8	Failed	Failed	1	2.1	Failed	18	Failed	Failed	1.1	1.9	Failed	22.3	Failed	Failed

**6.2.2.1.2.3 Receiver maximum and minimum power levels**

The demodulator maximum and minimum level tests were carried out according to the established procedures described in Section 4.2.3.2.3 on the Phase 2 document, with same attenuation for the Vertical and Horizontal polarizations. Note that the maximum level was limited to the maximum power

specified by the manufacturer. The tests for the receiver maximum and minimum levels were conducted according to the established procedures and parameters and are presented in Table A 29 and

Table A 30.

**Table A 29 - Receiver Maximum and Minimum Level for Single Layer**

CH	Config 1		Config 5	
	Maximum Level (dBm) <sup>2</sup>	Minimum Level (dBm)	Maximum Level (dBm) <sup>2</sup>	Minimum Level (dBm)
	LA		LA	
10	> - 10.2	- 103.3	> - 10.2	- 104
30	> - 10.2	- 103.7	> - 10.2	- 100.8

**Table A 30 - Receiver Maximum and Minimum Level for Dual Layer**

CH	Config 2				Config 9			
	Maximum Level (dBm) <sup>2</sup>		Minimum Level (dBm)		Maximum Level (dBm) <sup>2</sup>		Minimum Level (dBm)	
	LA	LB	LA	LB	LA	LB	LA	LB
10	> - 10.2	> - 10.2	- 104.1	- 89.5	> - 10.2	> - 10.2	- 103.5	- 87.9
30	> - 10.2	> - 10.2	- 102.2	- 87.5	> - 10.2	> - 10.2	- 100.6	- 84.8

#### **6.2.2.1.2.4 Co-channel Interference with its own system**

The tests for co-channel interference with its own system were conducted with the test setup established in Section 4.2.3.2.4 of the test procedure of Phase 2. The tests were conducted with synchronization between the interfering and interfered signals. The results of the tests are presented in Table A 31 and

Table A 32.

<sup>2</sup> REMARK: - 10.2 dBm is the maximum level of test setup. The receiver maximum levels are well beyond the maximum test setup level.

**Table A 31 - Own system Co-channel interference for Single Layer**

CH	U Frequency Offset (kHz)	U Pilot Pattern	TX Sync	D = Config 1 U = Config 1	D = Config 5 U = Config 5	D = Config 5 U = Config 2
				LA - D/U (dB)	LA - D/U (dB)	LA - D/U (dB)
10	- 6.173	6 2	On	- 1.6	- 0.7	- 0.5
	- 3.086	6 2	On	- 1.7	- 0.8	- 0.5
	0	6 2	On	- 1.1	0.5	- 0.6
	3.086	6 2	On	- 1.7	- 0.8	- 0.6
	6.173	6 2	On	- 1.5	- 0.7	- 0.6
30	- 6.173	6 2	On	- 1.7	- 0.5	- 0.7
	- 3.086	6 2	On	- 1.8	- 0.5	- 0.8
	0	6 2	On	- 1.2	0.5	- 0.8
	3.086	6 2	On	- 1.8	- 0.9	- 0.9
	6.173	6 2	On	- 1.8	- 0.5	- 0.9

**Table A 32 - Own system Co-channel interference for Dual Layer**

CH	U Frequency Offset (kHz)	U Pilot Pattern	TX Sync	D = Config 2 U = Config 2		D = Config 9 U = Config 1		D = Config 9 U = Config 9	
				LA - D/U (dB)	LB - D/U (dB)	LA - D/U (dB)	LB - D/U (dB)	LA - D/U (dB)	LB - D/U (dB)
10	- 6.173	6 2	On	- 1.6	20.5	- 0.5	14.6	- 0.6	14.6
	- 3.086	6 2	On	- 1.6	20.5	- 0.6	14.6	- 0.5	14.7
	0	6 2	On	- 1	20.8	- 0.6	15	0.6	15.8
	3.086	6 2	On	- 1.7	20.6	- 0.6	14.6	- 0.5	14.6
	6.173	6 2	On	- 1.6	20.6	- 0.6	14.6	- 0.4	14.6
30	- 6.173	6 2	On	- 1.9	Not Tested	- 0.9	14.4	- 0.8	14.4
	- 3.086	6 2	On	- 1.8	Not Tested	- 0.8	14.4	- 0.5	14.6
	0	6 2	On	- 1.3	Not Tested	- 0.9	14.7	1.3	16.2
	3.086	6 2	On	- 1.8	Not Tested	- 0.5	14.5	- 0.5	14.7
	6.173	6 2	On	- 1.8	Not Tested	- 0.8	14.4	- 0.8	14.4

**6.2.2.1.2.5 Co-channel and adjacent channel interference (at N±1 and N±2 channels) to ISDB-T**

The tests of co-channel and adjacent channel interference to ISDB-T system were conducted according to the test setup and parameters established in Section 5.2.2.

The ISDB-T receiver used in the tests is a commercial STB. For the sake of reference, Section I.1 of Appendix I presents the results of ISDB-T STB, when submitted to another ISDB-T interfering signal.

Table A 33 presents the results of the tests for the Advanced ISDB-T interfering signal with ISDB-T RF input receiving a level of - 63 dBm. As the ISDB-T STB did not reach TOV with the maximum interfering level of Advanced ISDB-T, the ISDB-T RF input level was changed to - 73 dBm, to have a greater range of D/U value.

- Modulation: 64QAM;
- FEC: 3/4;
- Guard Interval: 1/8;
- Time Interleaver: 0;
- Shift: 1/7 MHz.

**Table A 33 - Results of co-channel and adjacent channel interference of Advanced ISDB-T to ISDB-T**

Desired Channel	Interferer Channel	Protection Ratio D/U (dB)
		D = ISDB-T U = Config 9 LA
CH10	CH8	- 40.8
	CH9	- 38.5
	CH10	16.6
	CH11	- 38.6
	CH12	- 40.3
CH30	CH28	- 40.8
	CH29	- 38.8
	CH30	16.7
	CH31	- 39
	CH32	- 40.7

#### **6.2.2.1.2.6 Adjacent channel interference (at $N\pm 1$ and $N\pm 2$ channels) with its Own System**

The tests of co-channel and adjacent channel interference of Advanced ISDB-T to Advanced ISDB-T were conducted according to the test setup and parameters established in Section 5.2.3. Table A 34 presents the results of the tests for the Advanced ISDB-T interfering signal with Advanced ISDB-T RF input.

**Table A 34 - Results of adjacent channel interference of Advanced ISDB-T to Advanced ISDB-T**

Desired Channel	Interferer Channel	Protection Ratio D/U (dB)					
		D = Config 5 U = Config 2	D = Config 5 U = Config 5	D = Config 9 U = Config 1		D = Config 9 U = Config 9	
		LA	LA	LA	LB	LA	LB
CH10	CH8	- 37.8	- 37.7	- 37.9	- 21.5	- 37.8	- 21.4
	CH9	- 34.8	- 34.7	- 34.9	- 17.9	- 34.8	- 17.7
	CH11	- 35.2	- 35.1	- 35.3	- 18.4	- 35.4	- 17.8
	CH12	- 37.8	- 37.7	- 37.9	- 21.9	- 37.9	- 21.7
CH30	CH28	- 38.3	- 38	- 38.4	- 22.5	- 38.1	- 22.1
	CH29	- 35.3	- 34.8	- 35.3	- 18.9	- 35	- 18.4
	CH31	- 35.8	- 35.3	- 35.7	- 19	- 35.4	- 16.1
	CH32	- 38.3	- 37.5	- 38.2	- 22.6	- 37.9	- 22.2

#### **6.2.2.1.2.7 Co-Channel and Adjacent channel interference (at $N\pm 1$ and $N\pm 2$ channels) of the ISDB-T to Advanced ISDB-T**

The tests of co-channel and adjacent channel interference of ISDB-T system to ISDB-T Advanced were conducted according to the test setup and parameters established in Section 5.2.4.

Table A 35 presents the results of the tests for the ISDB-T interfering signal with Advanced ISDB-T RF input.

**Table A 35 - Results of co-channel and adjacent channel interference of ISDB-T to Advanced ISDB-T**

Desired Channel	Interferer Channel	Protection Ratio D/U (dB)	
		D = Config 9	
		U = ISDB-T	
		LA	LB
CH10	CH8	- 63.7	- 45.8
	CH9	- 57.5	- 39.9
	CH10	- 0.9	14.9
	CH11	- 57.8	- 40
	CH12	- 64.6	- 46.6
CH30	CH28	- 64.5	- 47.5
	CH29	- 57.6	- 40.4
	CH30	- 1.1	14.8
	CH31	- 57.5	- 40.4
	CH32	- 64.3	- 47.7

### 6.2.2.1.2.8 Impulsive noise

The tests of interference of impulsive noise were conducted according to the test setup and the procedures established in Section 5.2.5. Table A 36 summarizes the test results for the single- and dual-layer cases. The maximum impulsive noise of the test setup allowed a maximum C/Neq of - 43.7 dB in the VHF channel 10 and - 41 dB in CH30. In most of the test configurations the Advanced ISDB-T system did not reach QEF with the maximum interference level. As the Advanced ISDB-T receiver did not present QEF in many configurations of Impulsive Noise, the tests were conducted with an additional desired signal level of - 63 dBm, to reach higher C/Neq values.

**Table A 36 - Impulsive Noise interference test results (D = - 63 dBm)**

Noise Type	Config 5		Config 9	
	C/Neq (dB)		C/Neq (dB)	
	CH10	CH30	CH30	
			LA	LB
N1	- 43.7	- 40.8	- 41	- 40.5
N2	- 43.7	- 40.8	- 41	- 40.5
N3	- 43.7	- 40.8	- 41	- 40.5
N4	- 43.7	- 40.8	- 41	- 40.5
N5	- 43.7	- 40.8	- 41	- 40.5
N6	- 43.7	- 40.8	- 41	- 40.5
N7	- 43.7	- 40.8	- 41	- 40.5
N8 (1 μs)	- 43.7	- 40.8	- 41	- 40.5
N8 (10 μs)	- 43.7	- 40.8	- 41	- 40.4
N8 (20 μs)	- 43.7	- 40.8	- 41.0	- 32.1
N8 (30 μs)	- 43.7	- 40.8	- 41.0	- 12.4
N8 (40 μs)	- 43.7	- 40.8	- 41.0	- 10.1
N8 (50 μs)	- 43.7	- 40.8	- 41.0	- 8.8
N8 (60 μs)	- 43.7	- 40.8	- 41.0	- 7.4
N8 (70 μs)	- 43.7	- 40.8	- 41.0	- 7.2
N8 (80 μs)	- 43.7	- 40.8	- 41.0	- 6.6
N8 (90 μs)	- 43.7	- 40.8	- 41.0	- 6.1
N8 (100 μs)	- 43.7	- 40.8	- 41.0	- 5.6
N8 (150 μs)	- 43.7	- 40.8	- 41.0	- 3.9
N8 (200 μs)	- 43.7	- 40.8	- 41.0	- 2.6
N8 (250 μs)	- 43.7	- 40.8	- 41.0	- 1.7
N8 (300 μs)	- 43.7	- 40.8	- 41.0	- 0.9
N8 (350 μs)	- 43.7	- 40.8	- 41.0	- 0.3
N8 (400 μs)	- 43.7	- 40.8	- 41.0	0.4
N8 (450 μs)	- 43.7	- 40.8	- 41.0	1.0
N8 (500 μs)	- 43.7	- 40.8	- 41.0	1.5
N8 (600 μs)	- 43.7	- 40.8	- 41.0	2.2
N8 (700 μs)	- 27.7	- 24.9	- 26.2	2.8
N8 (800 μs)	- 14.4	- 15.2	- 15.3	3.4
N8 (900 μs)	- 13.5	- 14.3	- 14.4	3.9



### 6.2.2.1.2.9 Single echo static multipath interference

The tests of single echo static multipath interference were conducted according to the test setup and procedures established in Section 5.2.6. The results for the CH30 are presented in the Table A 37 and Table A 38.

**Table A 37 - Single echo static multipath interference for CH30 - Config 5**

Pre-Echo – Config 5		Post-Echo – Config 5	
Delay (μs)	LA Echo Att (dB)	Delay (μs)	LA Echo att (dB)
1	0	1	0
10	0	10	0
50	0	50	0
90	0	90	0
91	0	91	0
92	0	92	0
95	0	95	0
100	0	100	0
110	0	110	0
120	0	120	0
126	0	126	0
150	0	150	0
300	0	300	0

**Table A 38 - Single echo static multipath interference for CH30 - Config 9**

Pre-Echo – Config 9			Post-Echo – Config 9		
Delay (μs)	LA Echo Att (dB)	LB Echo Att (dB)	Delay (μs)	LA Echo Att (dB)	LB Echo Att (dB)
1	0	0	1	0	0
10	0	0	10	0	0
50	0	0	50	0	0
100	0	2.8	100	0	2.2
111	0	8.2	111	0	6.9
113.4	0	9.4	113.4	0	7.8
122.1	0	11.8	122.1	0	10.9
126	0	12.9	126	0	12.3
138.6	0	14.4	138.6	0	14.3
150	6	14.9	150	0	15
200	18	29.5	200	0	15
250	30	29.9	250	0	14.9
300	23.8	24	300	0	15.1

### 6.2.2.1.2.10 Channel bonding

The Channel Bonding verification follows the test procedure described in Section 4.2.3.2.8 of the Phase 2 document. The equipment provided by the proponent has the Channel Bonding capability, combining the same information in more than one channel, enhancing reliability and data throughput. It is implemented with the same transmission CH10 and CH30, operating simultaneously, with the proper channel bonding software used along the chain. The basic test setup is shown in Figure A 22.

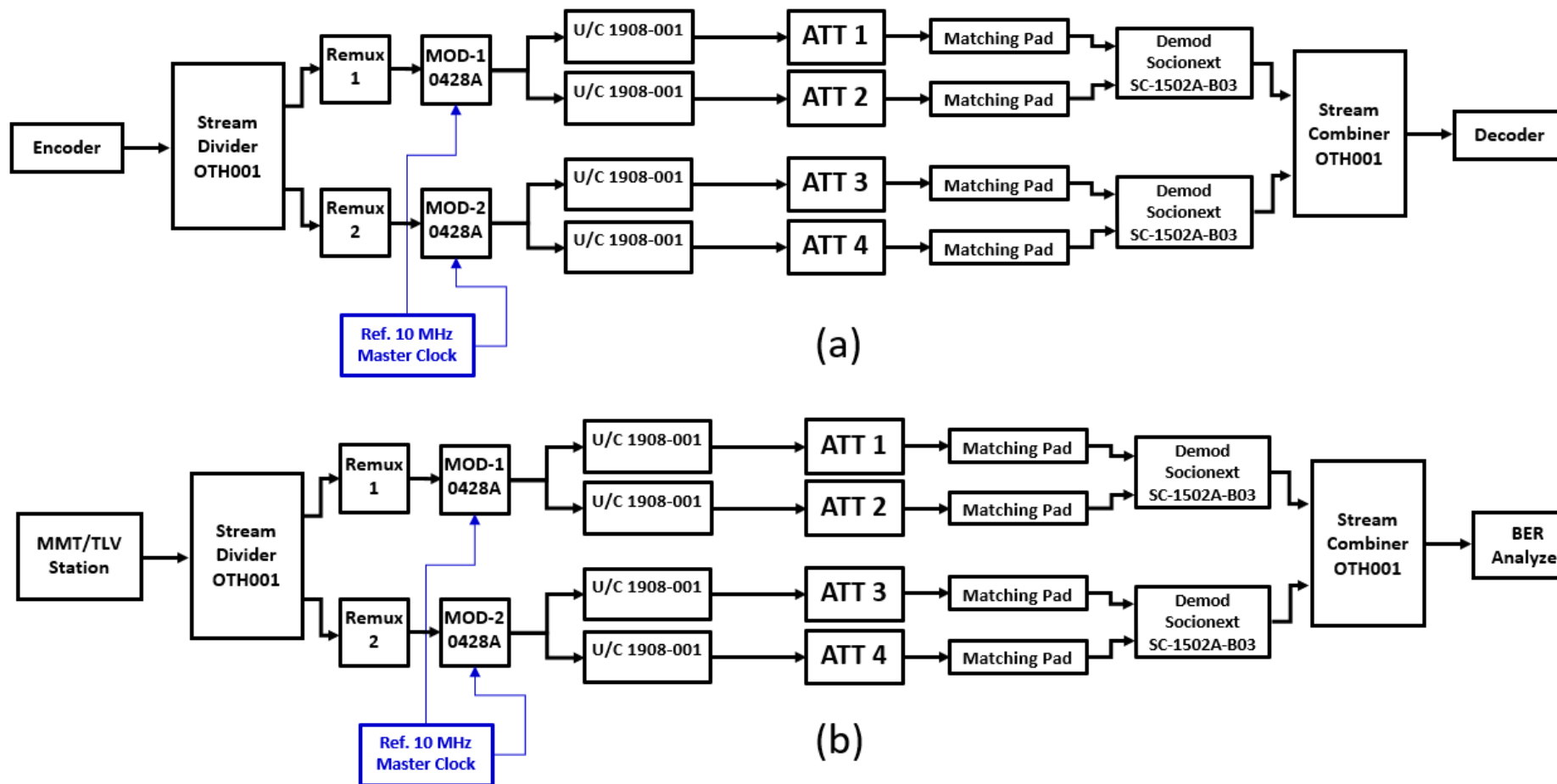


Figure A 22 - Channel Bonding setup (a) TOV, (b) PER measurement

The tests were conducted in channels 10, 30 and 36 in the combination shown in Table A 39 and Table A 40. The measurements observed audio and video and PER for three minutes.

**Table A 39 - Channel Bonding for Single Layer**

CH	Config	Bit Rate per channel (Mbps)	Total Bit Rate (Mbps)	QEF Criteria	Result
					LA
10	1	3.64	7.28	PER < 1x10 <sup>-4</sup>	Pass
30	1	3.64	7.28		
30	1	3.64	7.28	TOV	Pass
36	1	3.64	7.28		

**Table A 40 - Channel Bonding for Dual Layer**

CH	Config	Bit Rate per channel (Mbps)	Total Bit Rate (Mbps)	QEF Criteria	Result	
					LA	LB
10	2	LA = 1.98 LB = 27.01	LA = 3.96 LB = 54.02	PER < 1x10 <sup>-4</sup>	Pass	Pass
30	2	LA = 1.98 LB = 27.01	LA = 3.96 LB = 54.02			
30	2	LA = 1.98 LB = 27.01	LA = 3.96 LB = 54.02	TOV	Pass	Pass
36	2	LA = 1.98 LB = 27.01	LA = 3.96 LB = 54.02			

**6.2.2.1.2.11 Channel identification stability in frequency reuse-1 condition**

The Channel Identification Stability in Frequency Reuse-1 condition verification follows the test procedure described in Section 4.2.3.2.9 of the Phase 2 document. The co-channel interference result with own system test was used for U signals. The tests were conducted in RF channels 10 and 30. Table A 41 shows the results of the frequency reuse-1 verification.

**Table A 41 - Stability in frequency reuse-1**

CH	U Frequency Offset (kHz)	U Pilot Pattern	TX Sync	D = Config 5 U = Config 5	D = Config 5 U = Config 2	D = Config 9 U = Config 9	
				LA D/U = 0 dB	LA D/U = 0 dB	LA D/U = 0dB	LB D/U = 16dB
10	- 6.173	6 2	On	Not Tested	Pass	Pass	Pass
	0	6 2	On	Not Tested	Failed	Not Tested	Not Tested
30	- 6.173	6 2	On	Pass	Not Tested	Pass	Pass
	- 3.086	6 2	On	Pass	Not Tested	Pass	Pass
	0	6 2	On	Failed	Not Tested	Failed	Failed

**6.2.2.1.3 Summary of Test Results****Table A 42 - Summary of Test Results - Candidate A**

use case		minimum technical specification		fulfillment	
PL1	Enable side-by-side operation with existing ISDB-T systems in the same frequency bands, with minimum impact over existing network planning.	PL1.1.1	frequency band	174-216 MHz	fulfilled
		PL1.1.2		174-230 MHz	not verified
		PL1.1.3		470-698 MHz	fulfilled
		PL1.1.4		other frequency bands	not verified
		PL1.2.1	channel bandwidth	6 MHz	fulfilled
		PL1.2.2		7 MHz	not verified
		PL1.2.3		8 MHz	not verified
		PL1.2.4		other channel bandwidths	not verified
		PL1.3	co-channel PR (wanted: ISDB-T / unwanted: TV 3.0)	≤ 19 dB	fulfilled
PL1.4	adjacent-channel PR (wanted: ISDB-T / unwanted: TV 3.0)	≤ -36 dB	fulfilled		
PL2	Enable scalable broadcast network deployment (in terms of coverage and capacity), flexible frequency reuse with spatial content segmentation (reuse-1), and the most efficient spectrum use possible, targeting both fixed indoor and mobile (high-speed) outdoor reception.	PL2.1	MIMO	2x2	fulfilled
		PL2.2	multi-RF channel transmission	channel bonding - content is spread over two or more RF channels	fulfilled
		PL2.3	high-speed reception	120 Km/h	partially fulfilled
		PL2.4	spectrum efficiency	bit/s/Hz @ C/N ≤ 0 dB in Rayleigh channel	0.81 bit/s/Hz 4.9 Mbps / 6 MHz (MIMO, single layer) @ C/N ≤ 0 dB <sup>3</sup> .  2.45 bit/s/Hz 3.5+11.2 Mbps / 6 MHz (MIMO, dual-layer) @ C/N ≤ 0 dB for main layer and C/N ≤ 16dB <sup>3</sup> .

<sup>3</sup> Configuration 1 was used for single layer and configuration 9 for dual layer.

use case		minimum technical specification		fulfillment
PL3	Provide "wake-up" capability for compatible receivers in case of an emergency warning.	PL3.1	"wake-up" capability	not verified
PL4	Enable future extensions to the physical layer (e.g., to support new modulation schemes).	PL4.1	extensibility	not verified

## 6.3 Candidate Technology B

The Candidate Technology B – ATSC 3.0 is a technology developed and standardized by ATSC in USA and already in operation, mainly in US and South Korea. So, the technology is well documented by the Standardization Organization, and many studies and papers are available.

### 6.3.1 Documentation Analysis

The proposed technology is standardized by the official ATSC organization. The proponent listed and provided the documents to official standards with the complete information related to the Physical Layer. The main documents presented by the proponent are listed as follows:

- [1] ATSC Recommended Practice A/64B:2008 - Transmission Measurement and Compliance for Digital Television
- [2] ATSC Standard A/321:2016 - System Discovery and Signaling
- [3] ATSC Standard A/324:2021 - Scheduler / Studio to Transmitter Link
- [4] ATSC Recommended Practice A/327:2020 - Guidelines for the Physical Layer Protocol
- [5] ATSC Standards Mapping to TV 3.0 CfP PHY OTA
- [6] CTA-CEB32.2:2018 - Recommended Practice for ATSC 3.0 Television Sets, Physical Layer
- [7] ATSC Response to TV 3.0 Additional Requirements - Physical Layer
- [8] ATSC Recommended Practice A/325:2017 - TG3/S32 Lab Performance Test Plan
- [9] ATSC Recommended Practice A/326:2017 - ATSC 3.0 Field Test Plan
- [10] ATSC Standard A/322:2021 - Physical Layer Protocol
- [11] ATSC IPR Statement and Letter of Commitment to SBTVD Forum

Besides the above document, Instruction Manuals of the equipment delivered to the Test Lab, as well as a series of papers concerning Digital Broadcasting, were submitted but are not listed here. Also, many meetings between Test Lab and proponent were convened, during the test period, on almost a weekly basis.

### 6.3.2 Test Results

The Lab tests for the ATSC 3.0 in this phase are performed only on UHF channel 33 (587 MHz) since exciters provided by the proponent are limited to UHF operation.

The Mackenzie's Digital TV Lab received from the proponent the following equipment listed on Table B 1.

**Table B 1 - List of equipment provided by ATSC**

Equipment	Quantity
ATSC 3.0 Modulator Channel Bounding CLA3-CB1000T	1
ATSC 3.0 Demodulator Channel Bounding CLA3-CB1000R	1
ATSC 3.0 Modulator MIMO CLA3-MM1000T	2
ATSC 3.0 Demodulator MIMO CLA3-MM1000R	2
CLA3-MM1000T cables and adapters (2x USB + AC + ETH + power adapter + USB adapter to 4 pins + 4 pins cable)	Set
CLA3-MM1000R Cables and Adapters (2x USB + AC + ETH + USB adapter for RS232 + 4 pin adapter)	Set

It was agreed to evaluate the ATSC 3.0 technology using the proponent recommended configuration and meeting the SBTVD forum requirements. With two sets of candidates for the system evaluation with different purpose/applications, the SBTVD forum has decided to test MIMO only with the config indicated on Table B 2 and Table B 3 for Single Layer and Table B 4 and

Table B 5 for Dual Layer. The QEF adopted was a Frame Error Rate (FER) of  $10^{-4}$ .

**Table B 2 - Single Layer MIMO 2x2 Configurations**

Parameter	Config 1	Config 3
	Core Layer (CL)	CL
Bandwidth	6 MHz	6 MHz
Useful Bandwidth	5.831 MHz	5.831 MHz
Modulation	QPSK	QPSK
Constellation	UC	UC
FEC	LDPC (3/15) 64800 + BCH	LDPC (4/15) 64800 + BCH
iFFT Size	16K	16K
GI Ratio	4_768 (111µs)	4_768 (111µs)
Pilot Pattern	MP8_2	MP8_2
Pilot Encoding	Walsh Hadamard (WP)	Walsh Hadamard (WP)
Num. of OFDM Symbols	98	98
Time Interleaver	CTI_1024	CTI_1024
Bit Rate (Mbps)	4.0	5.34

**Table B 3 – Additional configurations with Single Layer MIMO 2x2 Configurations**

Parameter	Config 8	Config 9	Config 10
	CL	CL	CL
Bandwidth	6 MHz	6 MHz	6 MHz
Useful Bandwidth	5.831 MHz	5.831 MHz	5.831 MHz
Modulation	256QAM	256QAM	256QAM
Constellation	NUC	NUC	NUC
FEC	LDPC (11/15) 64800 + BCH	LDPC (10/15) 64800 + BCH	LDPC (8/15) 64800 + BCH
iFFT Size	16K	16K	16K
GI Ratio	4_768 (111µs)	4_768 (111µs)	4_768 (111µs)
Pilot Pattern	MP8_2	MP8_2	MP8_2
Pilot Encoding	Walsh Hadamard (WP)	Walsh Hadamard (WP)	Walsh Hadamard (WP)
Num. of OFDM Symbols	98	98	98
Time Interleaver	CTI_1024	CTI_1024	CTI_1024
Bit Rate (Mbps)	57.08	51.86	41.44

**Table B 4 - Dual Layer MIMO 2x2 Configurations**

Parameter	Config 2		Config 4		Config 5		Config 7	
	CL	Enhanced Layer (EL)	CL	EL	CL	EL	CL	EL
Bandwidth	6 MHz		6 MHz		6 MHz		6 MHz	
Useful Bandwidth	5.831 MHz		5.831 MHz		5.831 MHz		5.831 MHz	
Modulation	QPSK	16QAM	QPSK	16QAM	QPSK	16QAM	QPSK	16QAM
Constellation	UC	NUC	UC	NUC	UC	NUC	UC	NUC
Injection Level	6 dB		6 dB		7 dB		10 dB	
FEC	LDPC (3/15) 64800 + BCH	LDPC (8/15) 64800 + BCH	LDPC (4/15) 64800 + BCH	LDPC (8/15) 64800 + BCH	LDPC (4/15) 64800 + BCH	LDPC (7/15) 64800 + BCH	LDPC (4/15) 64800 + BCH	LDPC (4/15) 64800 + BCH
iFFT Size	16K		16K		16K		16K	
GI Ratio	4_768 (111µs)		4_768 (111µs)		4_768 (111µs)		4_768 (111µs)	
Pilot Pattern	MP8_2		MP8_2		MP8_2		MP8_2	
Pilot Encoding	Walsh Hadamard (WP)		Walsh Hadamard (WP)		Walsh Hadamard (WP)		Walsh Hadamard (WP)	
Num. of OFDM Symbols	98		98		98		98	
Time Interleaver	CTI_1024		CTI_1024		CTI_1024		CTI_1024	
Bit Rate (Mbps)	4.0	20.1	5.34	20.1	5.34	18.82	5.34	10.7



**Table B 5 – Additional configurations in Dual Layer MIMO 2x2 Configurations**

Parameter	Config 6		Config 11	
	CL	EL	CL	EL
<b>Bandwidth</b>	6 MHz		6 MHz	
<b>Useful Bandwidth</b>	5.831 MHz		5.831 MHz	
<b>Modulation</b>	QPSK	16QAM	QPSK	QPSK
<b>Constellation</b>	UC	NUC	UC	UC
<b>Injection Level</b>	6 dB		13 dB	
<b>FEC</b>	LDPC (4/15) 64800 + BCH	LDPC (6/15) 64800 + BCH	LDPC (4/15) 64800 + BCH	LDPC (8/15) 64800 + BCH
<b>iFFT Size</b>	16K		16K	
<b>GI Ratio</b>	4_768 (111µs)		4_768 (111µs)	
<b>Pilot Pattern</b>	MP8_2		MP8_2	
<b>Pilot Encoding</b>	Walsh Hadamard (WP)		Walsh Hadamard (WP)	
<b>Num. of OFDM Symbols</b>	98		98	
<b>Time Interleaver</b>	CTI_1024		CTI_1024	
<b>Bit Rate (Mbps)</b>	5.4	16.3	5.4	10.8

Additional configurations tests are performed to provide a better understanding of the system behavior. In these cases, the system parameters are described in each performance test results.

### 6.3.2.1 Laboratory Tests

The Laboratory Tests are conducted inside a Faraday Cage, to avoid external interferences of TV, Radio, Wi-Fi, and other undesired RF sources, and under controlled temperature and humidity as specified in ABNT NBR 15604 standard.

All RF cabling, splitters, combiners, impedance converters and TOV monitoring system uses Test Lab equipment and resources.

#### 6.3.2.1.1 Device Verification Tests

The Device Verification tests are performed with the intention to verify the basic characteristics of the sample MIMO Exciter device itself, to give assurance of no significant interference, during the on-site field evaluation tests, on the other TV channels already in operation, and have no intention to be an evaluation item of the candidate TV 3.0 system.

### 6.3.2.1.1.1 RF Frequency Accuracy (precision)

The RF frequency accuracy was measured, following the procedure established in Section 5.1.1, at the output of the ATSC 3.0 Exciter. The ATSC 3.0 Exciter was configured to output a CW signal at the UHF CH33 center frequency. Differently from Phase 2, ATSC 3.0 exciter is prepared for MIMO and tests were performed in both polarizations. The ATSC 3.0 Exciter was measured with 1 PPS reference, Config 1 modulation parameters and results are shown in Table B 6 for the exciter A and B.

**Table B 6 - RF Frequency Accuracy**

Channel	Exciter	Polarization	Nominal RF Frequency (Hz)	Measured Frequency (MHz)	Deviation (ppm)
33 (584-590 MHz)	A	H	587.000000E+06	587.00001231	0.0210
		V	587.000000E+06	587.00001253	0.0213
	B	H	587.000000E+06	587.00000951	0.0162
		V	587.000000E+06	587.00000948	0.0161

### 6.3.2.1.1.2 Phase Noise of Local Oscillators

The RF Phase Noise was measured, following the procedure established in Section 4.2.3.1.2 of the “TV 3.0 CfP Phase 2 / Testing and Evaluation” document, at the output of the ATSC exciter submitted by the proponent, which was configured to output a CW signal. The measurements are done using external reference (1 PPS), Config 1 modulations and is presented in the Table B 7.

**Table B 7 - RF Phase Noise**

Exciter	Polarization	Integral (100 Hz–6 MHz) dBc
		CH33
A	H1	- 55.5
	V1	- 55.4
B	H1	- 54.9
	V1	- 54.5

### 6.3.2.1.1.3 RF Signal Power

The RF signal power was measured, following the procedure established in Section 4.2.3.1.3 of the “TV 3.0 CfP Phase 2 / Testing and Evaluation” document, at the output of the exciter submitted by the proponent, which was configured to output a CW signal polarization configured to maximum power. The measurements are done using external reference (1 PPS) and are presented in Table B 8.

Table B 8 - RF Signal Power

CH	Nominal RF Frequency (Hz)	Polarization	Measured Power (dBm) Exciter A	Measured Power (dBm) Exciter B
33 (567-572 MHz)	587.000000E+06	H1	5.508	4.698
		V1	5.408	5.778

#### 6.3.2.1.1.4 RF Out of Band Emissions and Linearity Characterization (Spectrum Mask)

The proponent informed that the emission mask to be adopted is defined in document A/64B-2008. "ATSC Recommended Practice: Transmission Measurement and Compliance for Digital Television". The specified emission mask is the same as the ATSC 1.0 system, which operates with 8-VSB modulation. The emission mask is shown in Figure B 1.

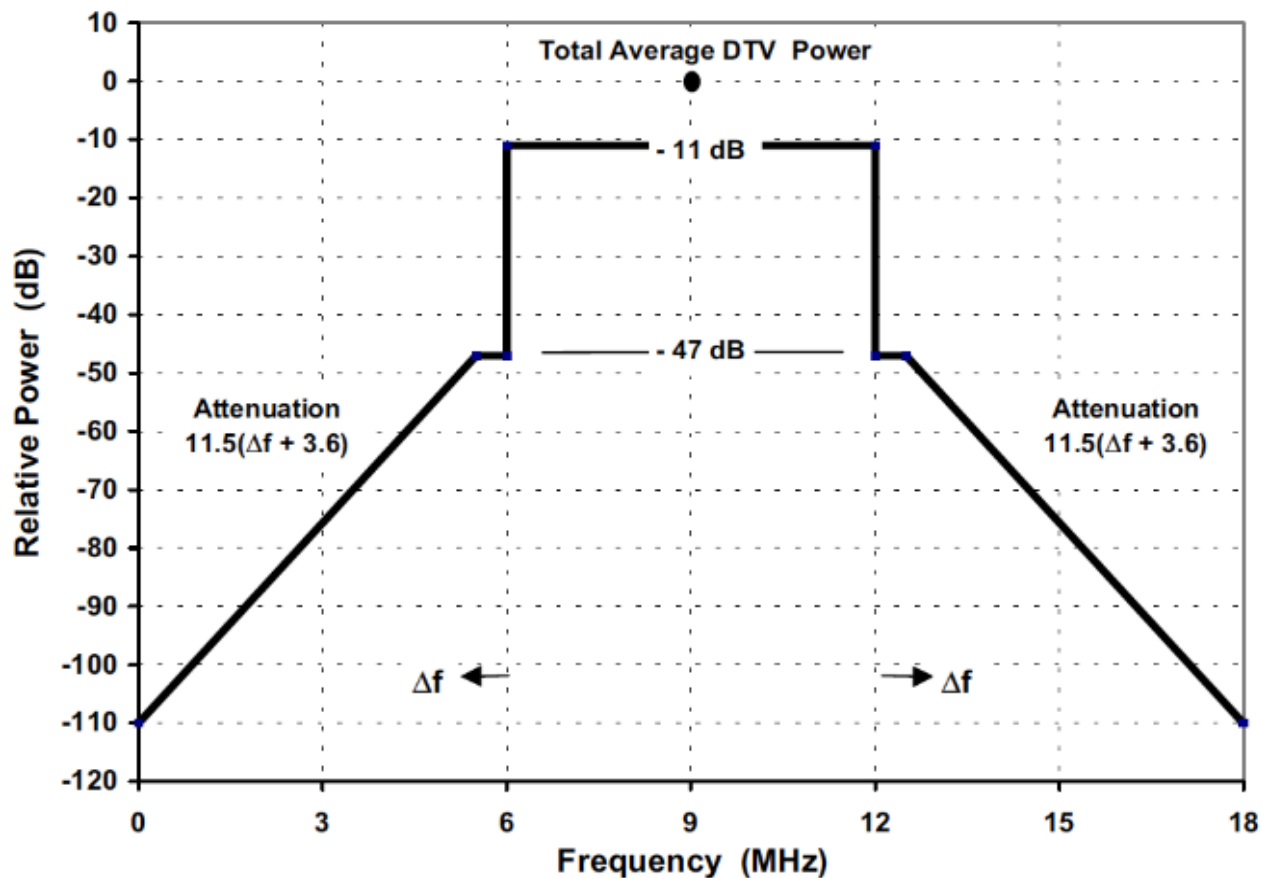
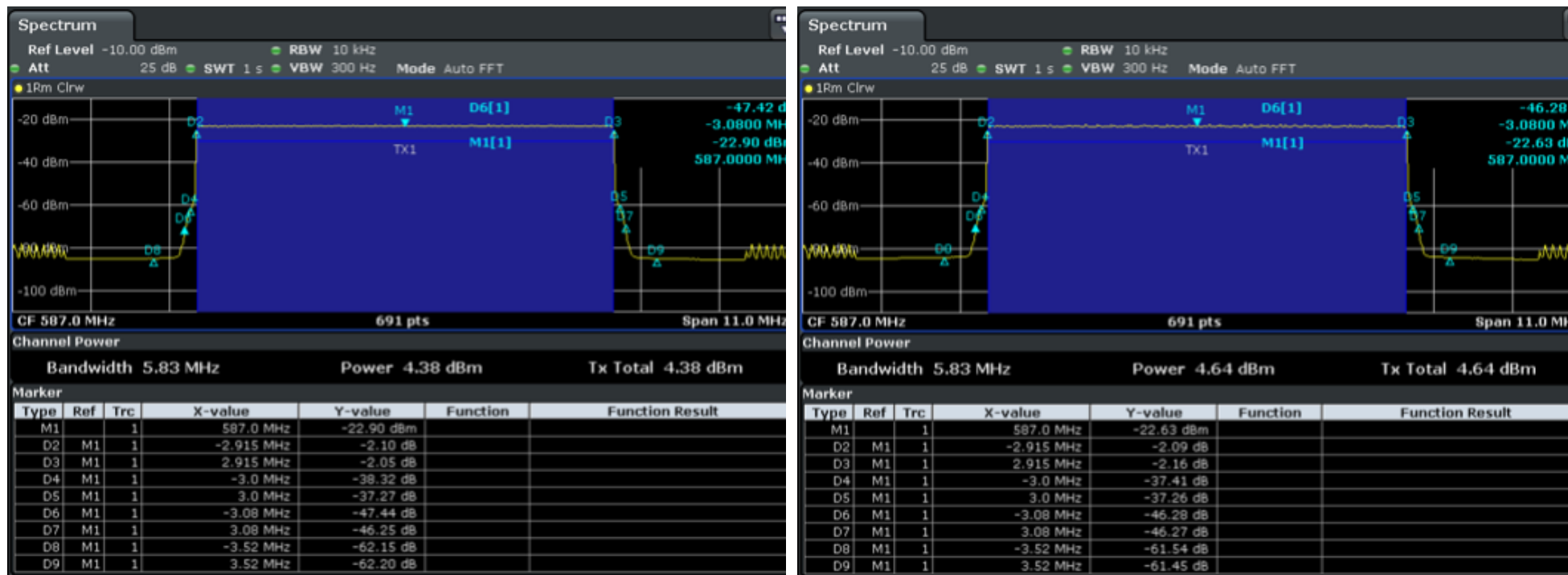


Figure B 1 - Emission mask specification for ATSC 3.0 with measurement bandwidth of 500 kHz

The Spectrum Mask was measured, following the procedure established in Section 4.2.3.1.4 of the “TV 3.0 CfP Phase 2 / Testing and Evaluation” document, at the output of the exciter submitted by the proponent. The spectrum mask in both exciters was analyzed for Config1 configuration only and results are as presented on Figure B 2 for Exciter A and Figure B 3 for Exciter B. Figure B 4 and Figure B 5 present the out of mask emissions for Exciter A and B subsequently.



a)

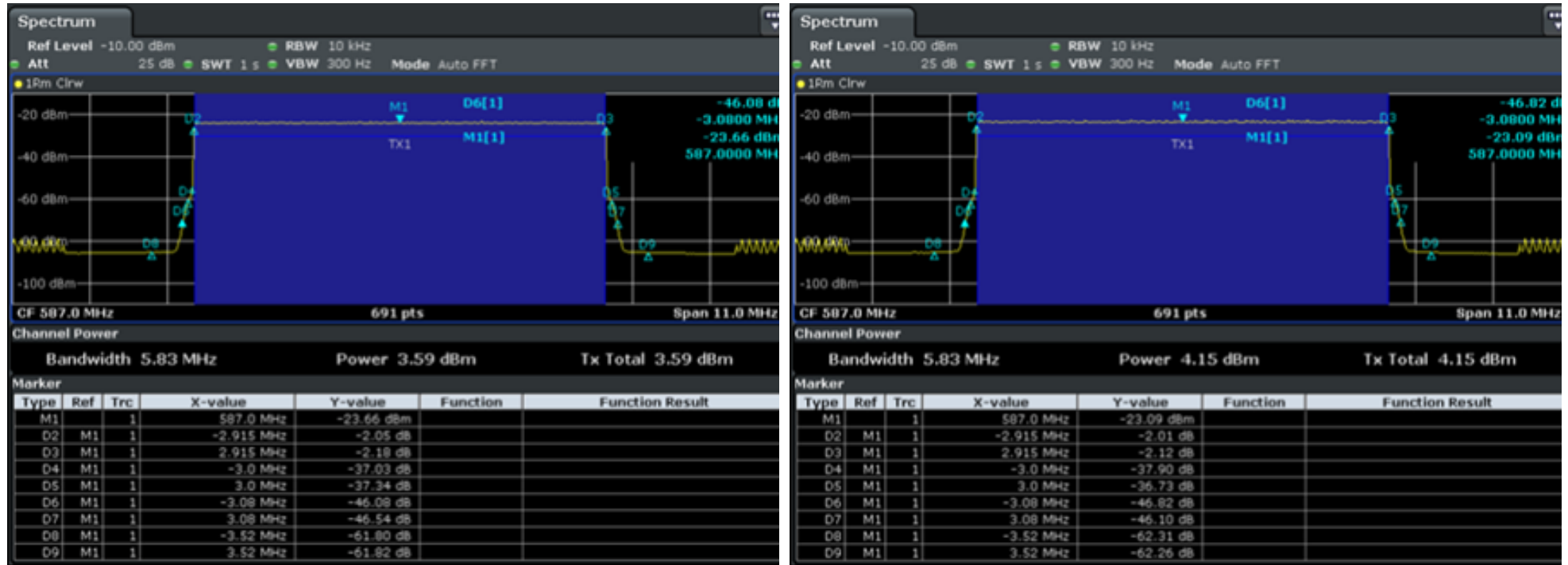
b)

Figure B 2 - Exciter A Spectrum Mask (a) Horizontal Polarization, (b) Vertical Polarization

Table B 9 shows the mask result compared to the ATSC Mask recommendation for Exciter A.

Table B 9 - MASK for Single Layer - Exciter A

CH30 M1 = 569.142857 MHz			Horizontal		Vertical	
Marker Name	Delta Frequency (MHz)	Theoretical (dB)	Delta Value (dB)	Result	Delta Value (dB)	Result
D2	M1 - 2.915	$\leq 0$	- 2.1	OK	- 2.09	OK
D3	M1 + 2.915	$\leq 0$	- 2.05	OK	- 2.16	OK
D4	M1 - 3.000	$\leq - 20$	- 38.32	OK	- 37.41	OK
D5	M1 + 3.000	$\leq - 20$	- 37.27	OK	- 37.26	OK
D6	M1 - 3.08	$\leq - 27$	- 47.44	OK	- 46.28	OK
D7	M1 + 3.08	$\leq - 27$	- 46.25	OK	- 46.27	OK
D8	M1 - 3.52	$\leq - 50$	- 62.15	OK	- 61.54	OK
D9	M1 - 2.915	$\leq - 50$	- 62.2	OK	- 61.45	OK



a)

b)

Figure B 3 - Exciter B Spectrum Mask (a) Horizontal Polarization, (b) Vertical Polarization

Table B 10 shows the mask result compared to the ATSC Mask recommendation for the Exciter B.

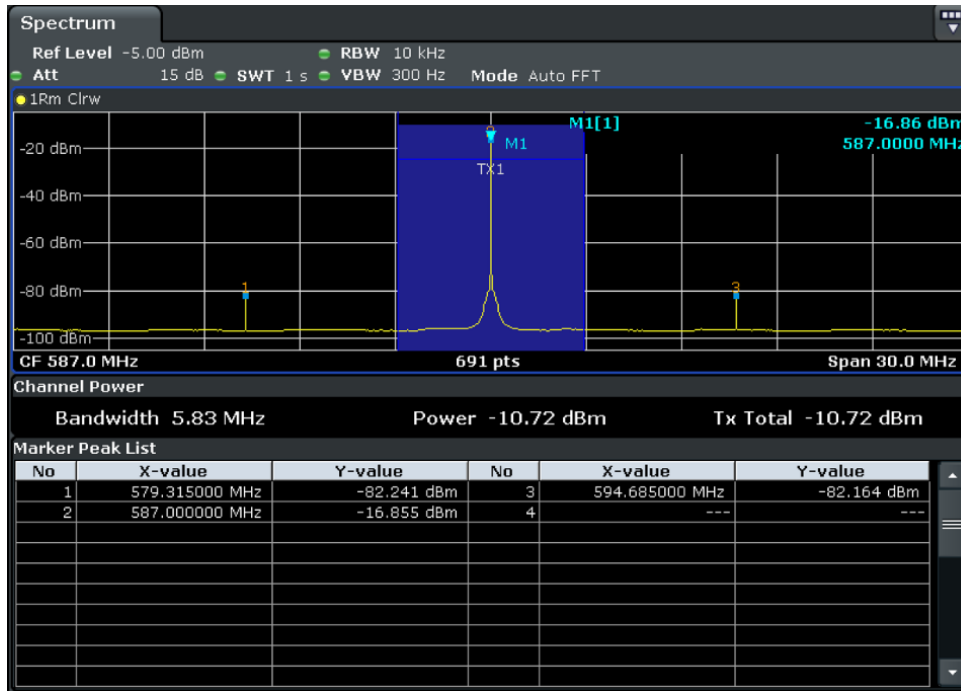
**Table B 10 - MASK for Single Layer - Exciter B**

CH30 M1 = 569.142857 MHz			Horizontal		Vertical	
Marker Name	Delta Frequency (MHz)	Theoretical (dB)	Delta Value (dB)	Result	Delta Value (dB)	Result
D2	M1 - 2.915	≤ 0	- 2.05	OK	- 2.01	OK
D3	M1 + 2.915	≤ 0	- 2.18	OK	- 2.12	OK
D4	M1 - 3.000	≤ - 20	- 37.03	OK	- 37.9	OK
D5	M1 + 3.000	≤ - 20	- 37.34	OK	- 36.73	OK
D6	M1 - 3.08	≤ - 27	- 46.08	OK	- 46.82	OK
D7	M1 + 3.08	≤ - 27	- 46.54	OK	- 46.1	OK
D8	M1 - 3.52	≤ - 50	- 61.8	OK	- 62.31	OK
D9	M1 - 2.915	≤ - 50	- 61.82	OK	- 62.26	OK

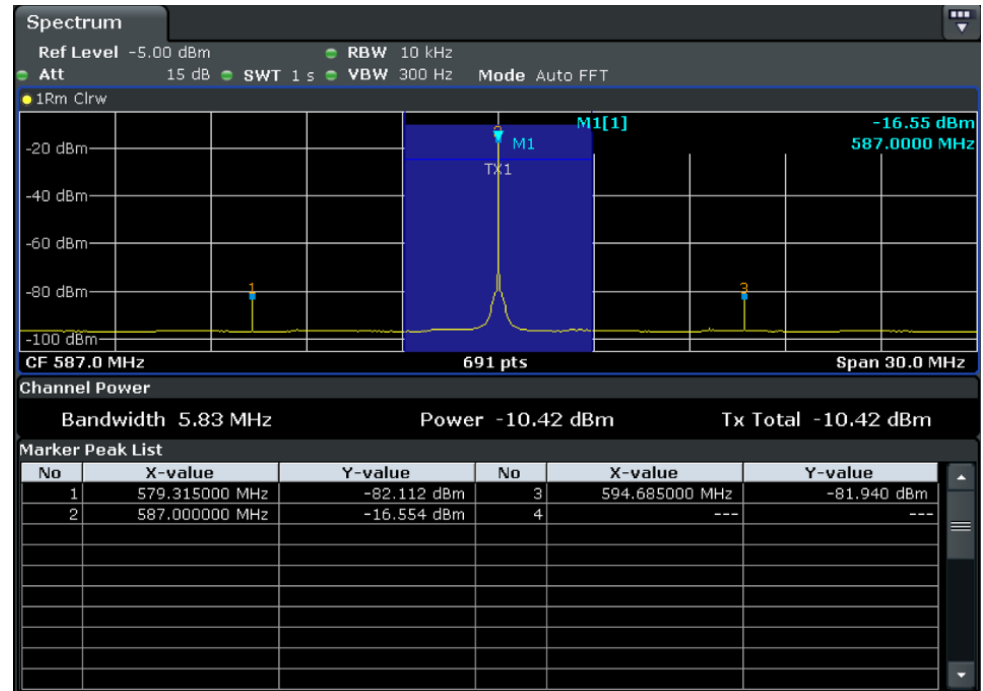
Results are within Recommended ATSC Mask for both Exciters.

The RF Out-of-Band Emissions were measured, following the procedure established in Section 4.2.3.1.4 of the “TV 3.0 CfP Phase 2 / Testing and Evaluation” document, at the output of the exciter submitted by the proponent, which was configured to output a CW signal. The results for Exciter A are presented in Figure B 4 and for Exciter B in Figure B 5.





(a)



(b)

Figure B 4 - Out-of-Band Emissions of Exciter A (a) Horizontal Polarization, (b) Vertical Polarization



a)

b)

**Figure B 5 - Out-of-Band Emissions of Exciter B (a) Horizontal Polarization, (b) Vertical Polarization**

### 6.3.2.1.1.5 I/Q Analysis – Constellation and MER

The I/Q Analysis – Constellation and MER were measured, following the procedure established in Section 4.2.3.1.5 of the “TV 3.0 CfP Phase 2 / Testing and Evaluation” document, at the output of the exciters submitted by the proponent. The constellation and the MER of the RF signal generated by the ATSC 3.0 exciter were observed by means of the two demodulators CLA3 MM1000R. Figure B 6 and Figure B 7 presents the constellation pictures for System A and B, respectively, with single layer configuration (Config 1). Figure B 8 and Figure B 9 shows results for both exciters configured with 2 Layers (Config 2).

In the configuration with one layer, referred as Single Layer, only PLP0 is active. In the Dual Layer setup, referred as LDM, the PLP0 is used for the Core Layer and the PLP1 is used for the Enhanced Layer.

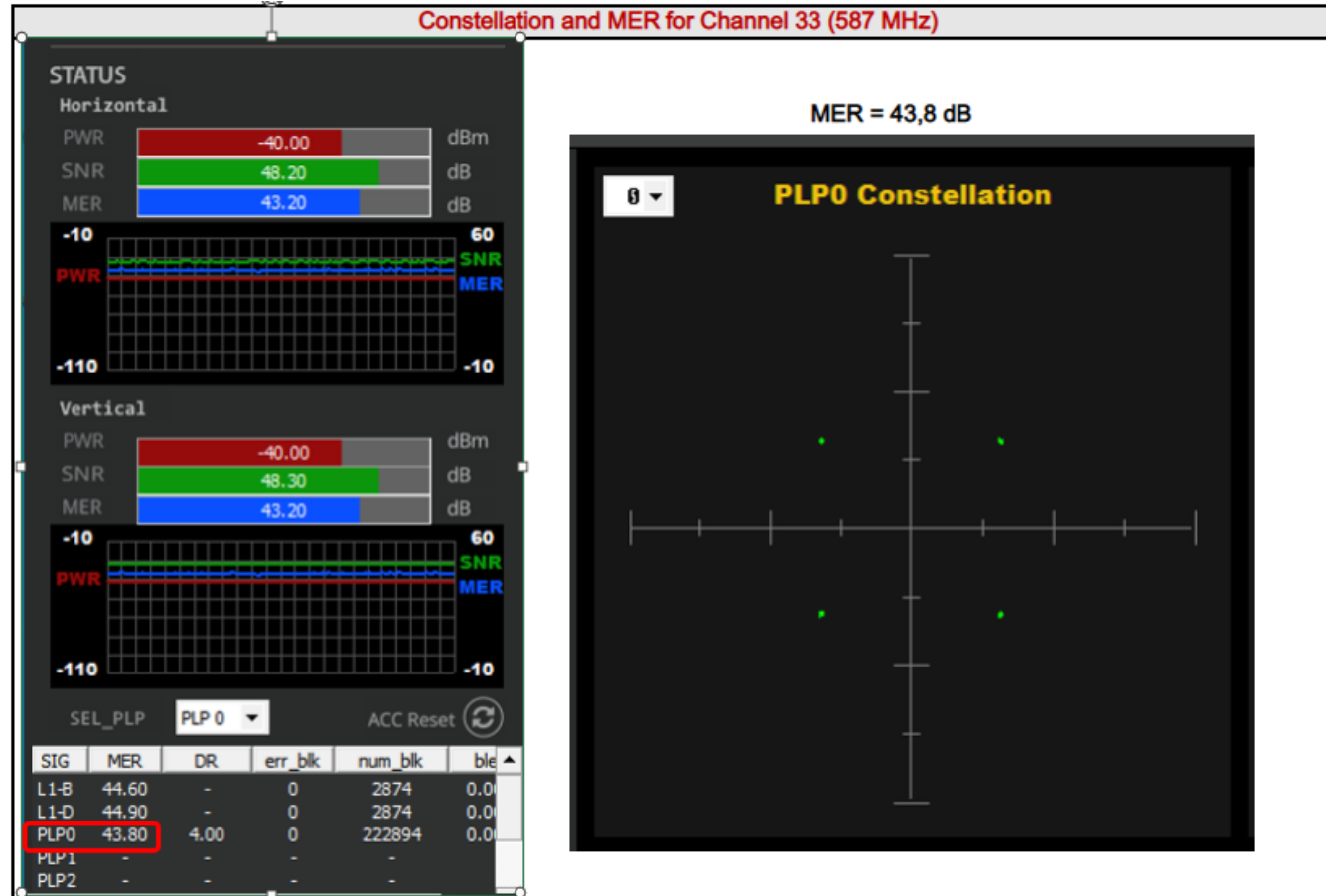


Figure B 6 - Constellation and MER of CH33 for Single Layer - System A

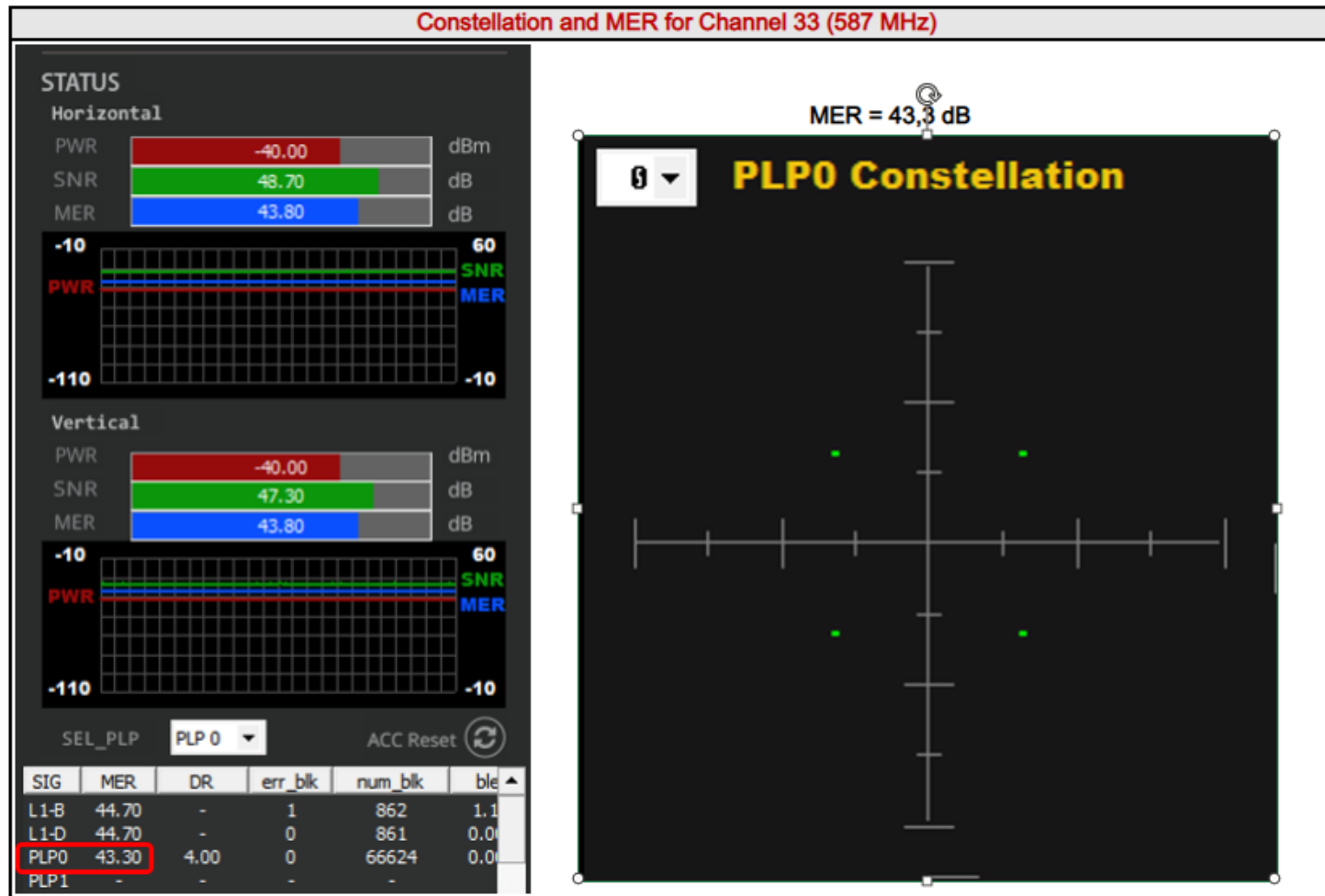


Figure B 7 - Constellation and MER of CH33 for Single Layer - System B

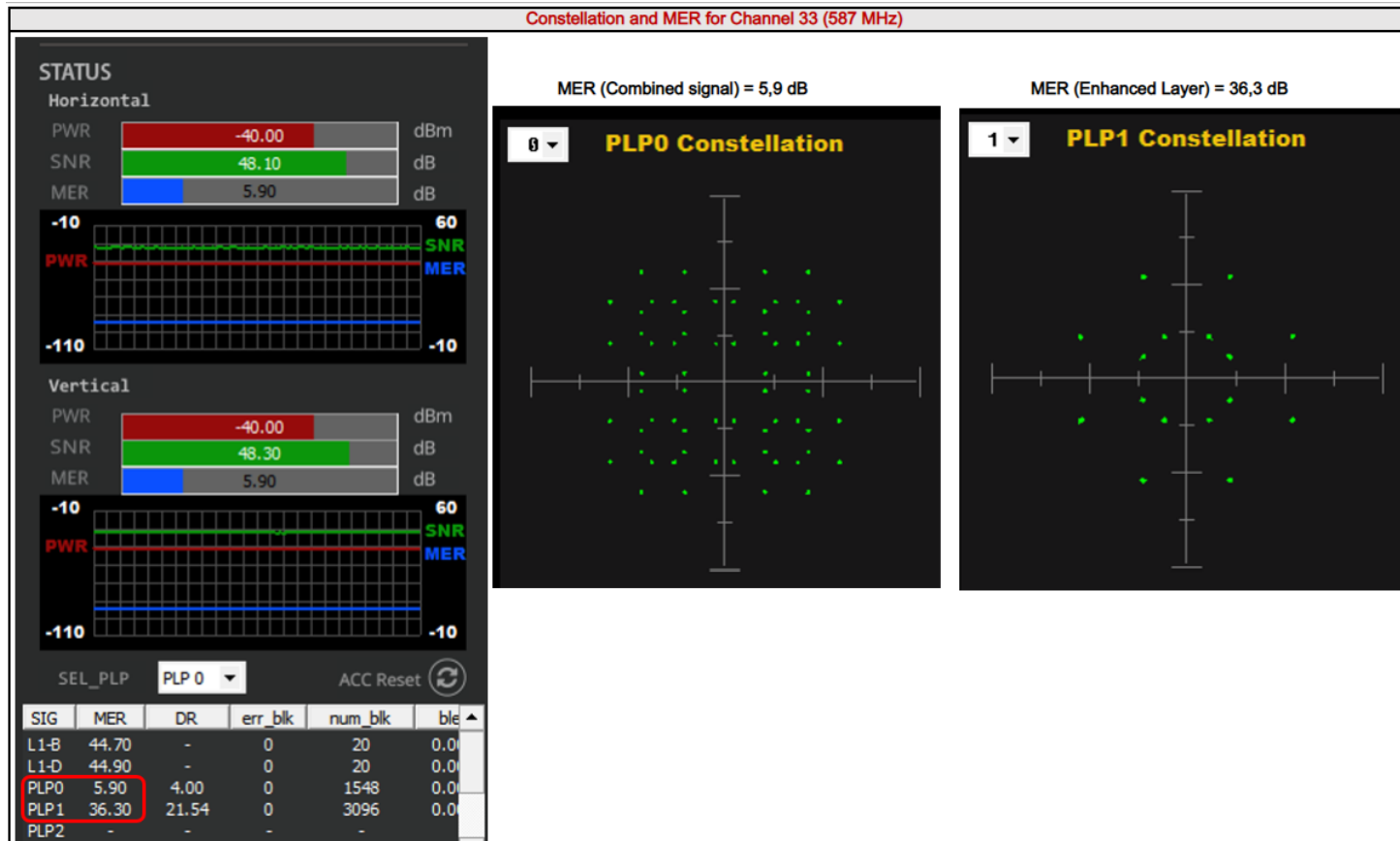


Figure B 8 - Constellation and MER of CH33 for Dual Layer (LDM) - System A

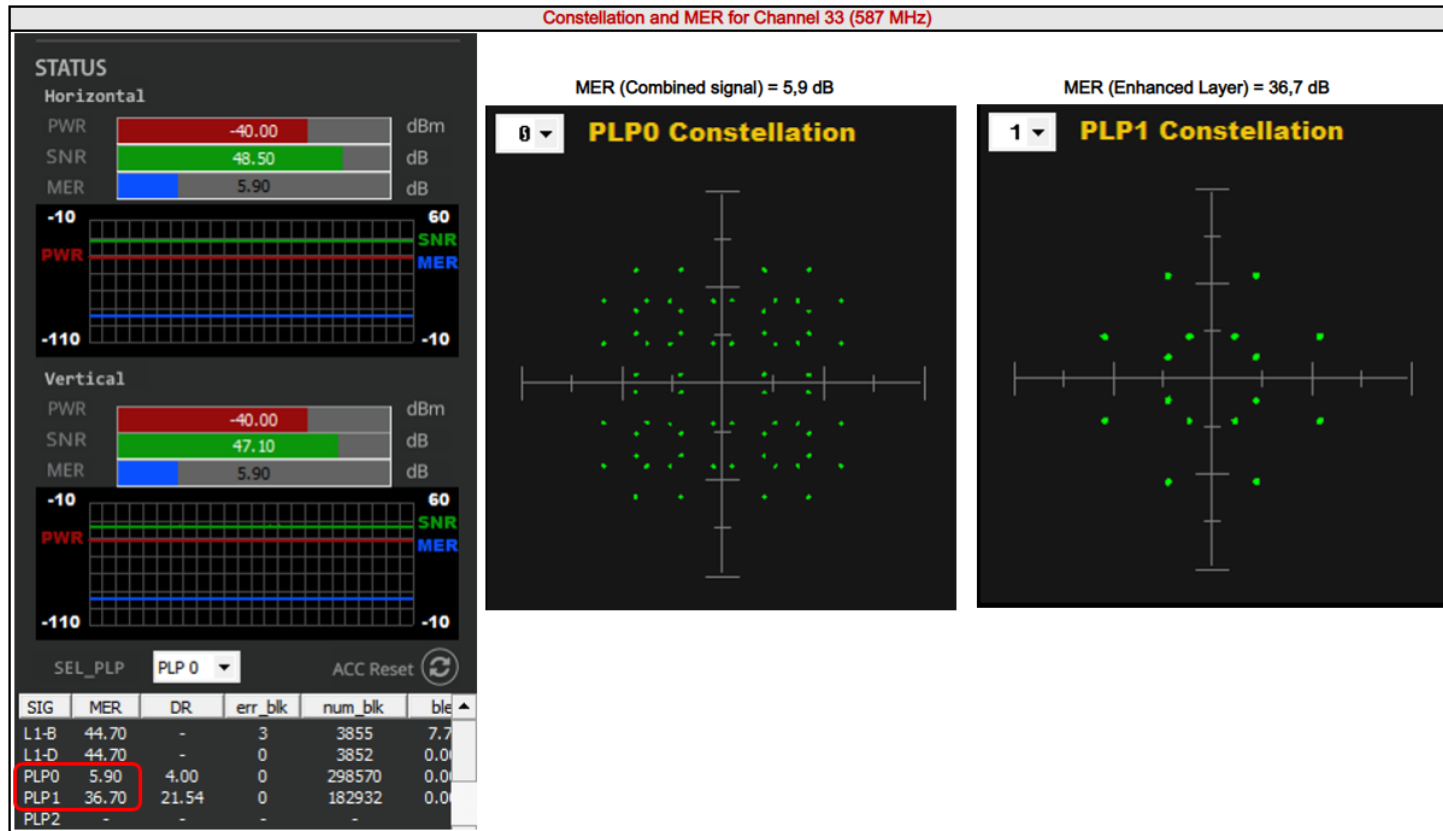


Figure B 9 - Constellation and MER of CH33 for Dual Layer (LDM) - System B

### 6.3.2.1.2 Evaluation Tests

The Verifications Tests presented results that allowed us to proceed to the Evaluation Tests. All tests are done with MIMO configuration.

#### 6.3.2.1.2.1 C/N – Carrier power vs AWGN

The C/N tests over AWGN channel results are present below and follow the test procedure described in Section 4.2.3.2.1 of the Phase 2 document and the results are presented in Table B 11 for Single Layer and in Table B 12 for Dual Layer (LDM).

**Table B 11 - C/N - Single Layer**

CH33	Results			
	C/N (dB)			
	C = - 28 dBm	C = - 53 dBm	C = - 68 dBm	C = - 83 dBm
Config 1	- 2.8	- 2.8	- 2.8	- 2.7
Config 3	- 1.6	- 1.6	- 1.6	- 1.6
Config 8	20.4	20.4	20.5	28.8
Config 9	18.9	18.9	19	24
Config 10	15.8	15.8	15.9	18

**Table B 12 - C/N - Dual Layer**

CH33	Results							
	C/N (dB)							
	C = - 28 dBm		C = - 53 dBm		C = - 68 dBm		C = - 83 dBm	
	CL	EL	CL	EL	CL	EL	CL	EL
Config 2	- 1	15	- 1	15	- 1	15	- 1	17
Config 4	- 0.4	16	- 0.4	16	- 0.4	16	- 0.4	18.3
Config 5	- 0.4	14.6	- 0.4	14.6	- 0.4	14.6	- 0.3	16.2
Config 6	-0.9	13.9	-0.9	13.9	-0.8	14	-0.9	14.9
Config 7	- 0.9	14.6	- 0.9	14.6	- 1	14.6	- 0.9	16
Config 11	-1.3	15.5	-1.3	15.5	-1.3	15.6	-1.3	18.2

### 6.3.2.1.2.2 C/N – Carrier power vs Noise Power in Rayleigh and AWGN Channels

The C/N over Rayleigh and AWGN channel was conducted according to Section 5.2.1, including the fading parameters. The results are presented in Table B 13 to Table B 24.

**Table B 13 - C/N over Rayleigh Ensemble RF1 for Single Layer**

CH33	Results							
	C/N (dB)							
	C = - 28 dBm		C = - 53 dBm		C = - 68 dBm		C = - 83 dBm	
Speed (Km/h)	0	3	0	3	0	3	0	3
Config 1	- 2.7	-2.8	- 2.8	-2.8	- 2.8	-2.8	- 2.7	-2.8
Config 3	- 1.6	-1.6	- 1.6	-1.6	- 1.6	-1.6	- 1.6	-1.6
Config 8	20.4	20.7	20.4	20.7	20.5	20.8	Failed	Failed
Config 9	19	19	19	19	19.4	19.2	Failed	25.5
Config 10	15.9	15.8	15.9	15.8	16.1	15.9	Failed	25

**Table B 14 - C/N over Rayleigh Ensemble RF1 for Dual Layer**

CH33	Results															
	C/N (dB)															
	C = - 28 dBm				C = - 53 dBm				C = - 68 dBm				C = - 83 dBm			
	CL		EL		CL		EL		CL		EL		CL		EL	
Speed (Km/h)	0	3	0	3	0	3	0	3	0	3	0	3	0	3	0	3
<b>Config 2</b>	-1	-1.2	15	15	-1	-1	15	15	-1	-1	15	15	-1	-1	17	15.2
<b>Config 4</b>	-0.4	-0.4	16.1	16	-0.4	-0.4	16.1	16.2	-0.3	-0.4	16.1	16.2	-0.3	0	18.6	18.3
<b>Config 5</b>	-0.4	-0.4	14.6	14.6	-0.4	-0.4	14.6	14.6	-0.4	-0.4	14.6	14.6	-0.4	-0.4	16.2	14.6
<b>Config 6</b>	-0.9	-0.3	14.2	14.3	-0.9	-0.3	14.5	14.3	-0.8	-0.3	14.2	14.2	-0.9	-0.3	19.5	15.3
<b>Config 7</b>	-0.9	-0.9	14.6	14.4	-0.9	-1	14.6	14.4	-1	-1	14.6	14.4	-0.9	-1	16	15.7
<b>Config 11</b>	-1.3	-1.2	15.5	15.5	-1.3	-1.3	15.5	15.6	-1.3	-1.3	15.6	15.6	-1.3	-1.3	18.3	17.3

**Table B 15 - C/N over Rayleigh Ensemble RF2A for Single Layer**

CH33	Results							
	C/N (dB)							
	C = - 28 dBm		C = - 53 dBm		C = - 68 dBm		C = - 83 dBm	
Speed (Km/h)	0	3	0	3	0	3	0	3
<b>Config 1</b>	-2	13.5	-2	13.4	-2	13.4	-2	16.3
<b>Config 3</b>	-0.9	5.9	-0.9	5.8	-0.9	5.9	-0.9	6
<b>Config 8</b>	20.4	Failed	20.5	Failed	20.9	Failed	Failed	Failed
<b>Config 9</b>	19.7	Failed	19.7	Failed	20.7	Failed	Failed	Failed
<b>Config 10</b>	17	Failed	16.7	Failed	17	Failed	Failed	Failed

**Table B 16 - C/N over Rayleigh Ensemble RF2A for Dual Layer**

CH33	Results															
	C/N (dB)															
	C = - 28 dBm				C = - 53 dBm				C = - 68 dBm				C = - 83 dBm			
	CL		EL		CL		EL		CL		EL		CL		EL	
Speed (Km/h)	0	3	0	3	0	3	0	3	0	3	0	3	0	3	0	3
<b>Config 2</b>	-0.5	17.5	16	Failed	-0.5	17	16	Failed	-0.5	17.3	Failed	Failed	-0.5	17	Failed	Failed
<b>Config 4</b>	0.4	17.9	17	36	0.4	17	17	35.9	0.4	17	17	Failed	0.4	20	Failed	Failed
<b>Config 5</b>	0.4	18	15.4	Failed	0.4	18.2	15.4	Failed	0.4	18.2	15.4	Failed	0.5	18	17	Failed
<b>Config 6</b>	-0.1	20.4	14.9	35	-0.2	20.3	14.9	35	-0.1	20.3	14.9	Failed	-0.2	Failed	18	Failed
<b>Config 7</b>	0	17	15.1	37	0	19	15.1	37.6	0	19	15.1	Failed	0	20	Failed	Failed
<b>Config 11</b>	-0.6	15.5	16.3	Failed	-0.6	15.4	16.3	Failed	-0.6	15.6	16.3	Failed	-0.5	15.6	19.1	Failed



**Table B 17 - C/N over Rayleigh Ensemble RF2B for Single Layer**

CH33	Results							
	C/N (dB)							
	C = - 28 dBm		C = - 53 dBm		C = - 68 dBm		C = - 83 dBm	
Speed (Km/h)	0	3	0	3	0	3	0	3
Config 1	1.5	9.5	1.5	9.7	1.5	9.8	1.6	9.8
Config 3	2.7	10.4	2.7	10.4	2.6	10.4	2.7	10.4
Config 8	27	Failed	27.1	Failed	Failed	Failed	Failed	Failed
Config 9	24.5	Failed	24.5	Failed	30	Failed	Failed	Failed
Config 10	21	Failed	21	Failed	27	Failed	Failed	Failed

**Table B 18 - C/N over Rayleigh Ensemble RF2B for Dual Layer**

CH33	Results															
	C/N (dB)															
	C = - 28 dBm				C = - 53 dBm				C = - 68 dBm				C = - 83 dBm			
	CL		EL		CL		EL		CL		EL		CL		EL	
Speed (Km/h)	0	3	0	3	0	3	0	3	0	3	0	3	0	3	0	3
Config 2	3	10.5	21	Failed	3	10.8	20.9	Failed	3	12	Failed	Failed	3	12.5	Failed	Failed
Config 4	4.2	12	22.1	30.9	4.2	11	22.1	30.9	4.2	11	22.3	33	4.5	12.6	Failed	Failed
Config 5	4.2	12	20.9	29.5	4.2	12	20.9	30	4.2	12	21	30	4.3	12	Failed	Failed
Config 6	4.5	13	19.8	28	4.2	12.5	19.6	28	4.2	12.5	20	28.2	4.4	12.5	28	Failed
Config 7	3.5	11.4	20.4	29	3.5	11.4	20.4	29	3.5	11.4	20.5	32.5	3.6	11.4	Failed	Failed
Config 11	3.1	9.5	25.8	Failed	3.1	9.4	25.7	Failed	3.1	9.6	26.3	Failed	3.2	9.6	Failed	Failed

**Table B 19 - C/N over Rayleigh Ensemble RF3A for Single Layer**

CH33	Results											
	C/N (dB)											
	C = - 28 dBm			C = - 53 dBm			C = - 68 dBm			C = - 83 dBm		
Speed (Km/h)	0	50	120	0	50	120	0	50	120	0	50	120
Config 1	4.4	6	6	4.4	6	5.8	4.4	6.2	5.8	4.5	6.8	6.5
Config 3	5.9	7.6	Failed	5.9	7.6	Failed	6	7.6	Failed	6.1	7.7	Failed
Config 8	Failed	Failed	Failed	Failed	Failed	Failed	Failed	Failed	Failed	Failed	Failed	Failed
Config 9	36	Failed	Failed	36.7	Failed	Failed	Failed	Failed	Failed	Failed	Failed	Failed
Config 10	30.3	Failed	Failed	30.6	Failed	Failed	Failed	Failed	Failed	Failed	Failed	Failed

**Table B 20 - C/N over Rayleigh Ensemble RF3A for Dual Layer**

CH33	Results																							
	C/N (dB)																							
	C = - 28 dBm						C = - 53 dBm						C = - 68 dBm						C = - 83 dBm					
	CL			EL			CL			EL			CL			EL			CL			EL		
Speed (Km/h)	0	50	120	0	50	120	0	50	120	0	50	120	0	50	120	0	50	120	0	50	120	0	50	120
<b>Config 2</b>	6.2	7.8	10	31.4	Failed	Failed	6.1	7.6	9	Failed	Failed	Failed	6.2	7.8	9.7	Failed	Failed	Failed	6.3	7.9	9.7	Failed	Failed	Failed
<b>Config 4</b>	7.6	8.9	12	33.3	Failed	Failed	7.6	8.9	12	Failed	Failed	Failed	7.6	9.3	12	Failed	Failed	Failed	7.8	9.1	12.8	Failed	Failed	Failed
<b>Config 5</b>	7.6	8.9	12	31.7	Failed	Failed	7.6	9.2	13.1	31.8	Failed	Failed	7.6	9.1	12	Failed	Failed	Failed	7.8	9.6	13	Failed	Failed	Failed
<b>Config 6</b>	7.8	9.3	13	32.7	Failed	Failed	7.6	9.2	13	32.6	Failed	Failed	8.2	9	13	33	Failed	Failed	11.6	9.5	13.8	Failed	Failed	Failed
<b>Config 7</b>	7	8.5	10.7	31.7	Failed	Failed	6.8	8.3	10.7	Failed	Failed	Failed	7	8.4	11.7	34.2	Failed	Failed	7	8.7	11.7	Failed	Failed	Failed
<b>Config 11</b>	6.5	7.9	9.4	28.5	Failed	Failed	6.5	7.7	9.4	28.5	Failed	Failed	6.5	7.8	9.3	29.3	Failed	Failed	6.5	7.9	9.9	Failed	Failed	Failed

**Table B 21 - C/N over Rayleigh Ensemble RF3B for Single Layer**

CH33	Results											
	C/N (dB)											
	C = - 28 dBm			C = - 53 dBm			C = - 68 dBm			C = - 83 dBm		
	Speed (Km/h)	0	50	120	0	50	120	0	50	120	0	50
<b>Config 1</b>	4	Failed	Failed	4	Failed	Failed	4	Failed	Failed	4.1	Failed	Failed
<b>Config 3</b>	5.6	30.5	32.7	5.7	31.1	35	5.6	36.7	38	5.7	Failed	Failed
<b>Config 8</b>	Failed	Failed	Failed	Failed	Failed	Failed	Failed	Failed	Failed	Failed	Failed	Failed
<b>Config 9</b>	Failed	Failed	Failed	Failed	Failed	Failed	Failed	Failed	Failed	Failed	Failed	Failed
<b>Config 10</b>	Failed	Failed	Failed	Failed	Failed	Failed	Failed	Failed	Failed	Failed	Failed	Failed

**Table B 22 - C/N over Rayleigh Ensemble RF3B for Dual Layer**

CH33	Results																							
	C/N (dB)																							
	C = - 28 dBm						C = - 53 dBm						C = - 68 dBm						C = - 83 dBm					
	CL			EL			CL			EL			CL			EL			CL			EL		
Speed (Km/h)	0	50	120	0	50	120	0	50	120	0	50	120	0	50	120	0	50	120	0	50	120	0	50	120
<b>Config 2</b>	5.8	Failed	Failed	Failed	Failed	Failed	5.8	Failed	Failed	Failed	Failed	Failed	6	Failed	Failed	Failed	Failed	Failed	6	Failed	Failed	Failed	Failed	Failed
<b>Config 4</b>	7.5	Failed	Failed	Failed	Failed	Failed	7.5	Failed	Failed	Failed	Failed	Failed	7.5	Failed	Failed	Failed	Failed	Failed	Failed	Failed	Failed	Failed	Failed	Failed
<b>Config 5</b>	7.5	Failed	Failed	Failed	Failed	Failed	7.5	Failed	Failed	Failed	Failed	Failed	7.5	Failed	Failed	Failed	Failed	Failed	7.7	Failed	Failed	Failed	Failed	Failed
<b>Config 6</b>	7.5	Failed	Failed	Failed	Failed	Failed	7.5	Failed	Failed	Failed	Failed	Failed	7.5	Failed	Failed	Failed	Failed	Failed	8.4	Failed	Failed	Failed	Failed	Failed
<b>Config 7</b>	6.6	Failed	Failed	Failed	Failed	Failed	6.6	Failed	Failed	Failed	Failed	Failed	6.6	Failed	Failed	Failed	Failed	Failed	6.8	Failed	Failed	Failed	Failed	Failed
<b>Config 11</b>	6.1	Failed	Failed	Failed	Failed	Failed	6.2	24.4	Failed	Failed	Failed	Failed	6	24.8	Failed	Failed	Failed	Failed	6.3	Failed	Failed	Failed	Failed	Failed

Table B 23 - C/N over Rayleigh Ensemble RF4 for Single Layer

CH33	Results											
	C/N (dB)											
	C = - 28 dBm			C = - 53 dBm			C = - 68 dBm			C = - 83 dBm		
Speed (Km/h)	0	50	120	0	50	120	0	50	120	0	50	120
Config 1	3.4	5	5.8	3.4	5.2	6	3.4	5.8	5.5	3.4	5.2	5.7
Config 3	4.8	7	8.3	4.7	6.9	8.6	4.8	7	8.5	5	6.9	8.6
Config 8	29.4	Failed	Failed	29.5	Failed	Failed	37.7	Failed	Failed	Failed	Failed	Failed
Config 9	27.3	Failed	Failed	27.3	Failed	Failed	31.5	Failed	Failed	Failed	Failed	Failed
Config 10	25	Failed	Failed	24.4	Failed	Failed	25	Failed	Failed	Failed	Failed	Failed

Table B 24 - C/N over Rayleigh Ensemble RF4 for Dual Layer

CH33	Results																							
	C/N (dB)																							
	C = - 28 dBm						C = - 53 dBm						C = - 68 dBm						C = - 83 dBm					
	CL			EL			CL			EL			CL			EL			CL			EL		
Speed (Km/h)	0	50	120	0	50	120	0	50	120	0	50	120	0	50	120	0	50	120	0	50	120	0	50	120
Config 2	5	7.5	9.3	24.4	Failed	Failed	5	7.8	9.3	23.9	Failed	Failed	5	7.8	9.3	Failed	Failed	Failed	5	7.5	9.5	Failed	Failed	Failed
Config 4	6.4	8.4	12.5	25	Failed	Failed	6.4	9.1	12.1	24.9	Failed	Failed	6	9.1	12.4	24.9	Failed	Failed	6.5	9.1	15	Failed	Failed	Failed
Config 5	6.4	8.7	13.9	25.2	Failed	Failed	6.4	9	14	23.5	Failed	Failed	6.4	9	14.3	Failed	Failed	Failed	6.5	9	14.5	Failed	Failed	Failed
Config 6	6.5	9	14.2	22.3	Failed	Failed	6.5	9	14.4	22.3	Failed	Failed	6.5	8.8	14	22.3	Failed	Failed	6.5	8.8	15	Failed	Failed	Failed
Config 7	5.5	7.9	11.4	23.4	Failed	Failed	5.5	8	11.3	24.4	Failed	Failed	5.5	7.9	11.4	Failed	Failed	Failed	5.8	8	11.3	Failed	Failed	Failed
Config 11	3.3	7	10	26.5	Failed	Failed	3	7.2	10	26.5	Failed	Failed	3.3	7.2	10.1	Failed	Failed	Failed	3.4	7.4	10.1	Failed	Failed	Failed

### 6.3.2.1.2.3 Receiver Maximum and Minimum Level

The demodulator maximum and minimum level tests were carried out according to the established procedures described in Section 4.2.3.2.3 on the Phase 2 document, with same attenuation for the Vertical and Horizontal polarizations. Note that the maximum level was limited to the maximum power specified by the manufacturer. Tests were conducted on CH33, and results are presented on Table B 25 for Single Layer and Table B 26 for Dual Layer (LDM).

**Table B 25 - Maximum and Minimum level for Single Layer**

CH	Config 1		Config 3	
	Maximum Level <sup>4</sup> (dBm)*	Minimum Level (dBm)	Maximum Level <sup>4</sup> (dBm)	Minimum Level (dBm)
33	> - 20	- 106.5	> - 20	- 102

**Table B 26 - Maximum and Minimum level for Dual Layer**

CH	Config 2				Config 4			
	CL		EL		CL		EL	
	Maximum Level <sup>4</sup> (dBm)	Minimum Level (dBm)	Maximum Level <sup>4</sup> (dBm)	Minimum Level (dBm)	Maximum Level <sup>4</sup> (dBm)	Minimum Level (dBm)	Maximum Level <sup>4</sup> (dBm)	Minimum Level (dBm)
33	> - 20	- 105.9	> - 20	- 89.7	> - 20	- 106	> - 20	- 90.5

#### 6.3.2.1.2.4 Co-channel Interference with own system

The tests for co-channel interference with its own system were conducted with the test setup established in Section 4.2.3.2.4 of the test procedure of Phase 2. The tests were conducted with synchronization between the interfering and interfered signals. The results of the tests are presented in Table B 27 for Single Layer analysis and Table B 28 for Dual Layer.

**Table B 27 - ATSC 3.0 own system interference for Single Layer**

CH33	U	U	TX Sync	D = Config 1	D = Config 3
	Frequency Offset (Hz)	Pilot Pattern		U = Config 1	U = Config 3
				CL - D/U (dB)	CL - D/U (dB)
	0	8 2	Off	- 3.2	- 1.6
	0	8 2	On	- 3.3	- 1.9
	843.75	8 2	On	- 2.8	- 1.5
	- 843.75	8 2	On	- 2.8	- 1.6
	0	12 2	On	- 2.6	- 1.5
	0	8 4	On	- 2.6	- 1.6
	0	3 2	On	- 3.2	- 2.0

<sup>4</sup> Maximum level test was limited to the maximum power specified by the manufacturer.

**Table B 28 - ATSC 3.0 own system interference for Dual Layer**

CH33	U Frequency Offset (Hz)	U Pilot Pattern	TX Sync	D = Config 2 U = Config 2		D = Config 4 U = Config 4		D = Config 5 U = Config 5		D = Config 7 U = Config 7	
				CL - D/U (dB)	EL - D/U (dB)	CL - D/U (dB)	EL - D/U (dB)	CL - D/U (dB)	EL - D/U (dB)	CL - D/U (dB)	EL - D/U (dB)
				0	8 2	On	- 1.9	14.3	- 0.9	15.3	- 0.5
- 843.75	8 2	On	- 1.6	14.9	- 0.5	15.8	- 0.4	14.3	- 0.9	14.0	
843.75	8 2	On	- 0.8	14.5	- 0.5	15.8	- 0.5	14.4	- 0.9	14.0	

**6.3.2.1.2.5 Co-channel and Adjacent Channel Interference (at N±1 and N±2 channels) to ISDB-T**

The tests of co-channel and adjacent channel interference to ISDB-T system were conducted according to the test setup and parameters established in Section 5.2.2. Table B 29 presents the results of the ATSC 3.0 interference to ISDB-T.

The ISDB-T receiver used in the tests is a commercial STB with the ISDB-T RF input level set to - 63 dBm, to have a greater range of D/U value.

For the sake of reference, Section I.1 of Appendix I presents the results of ISDB-T STB, when submitted to another ISDB-T interfering signal.

- Modulation: 64QAM;
- FEC: 3/4;
- Guard Interval: 1/8;
- Time Interleaver: 0;
- Shift: 0.

**Table B 29 - Results of co-channel and adjacent channel interference of ATSC 3.0 to ISDB-T**

ISDB-T	Interferer Channel	Receiver D/U (dB)
		D = ISDB-T U = Config 2 CL
CH33	CH31	- 45.1
	CH32	- 42.0
	CH33	16.5
	CH34	- 41.2
	CH35	- 45.2

### 6.3.2.1.2.6 Adjacent channel interference (at $N\pm 1$ and $N\pm 2$ channels) with its Own System

The tests of adjacent channel interference of ATSC 3.0 to ATSC 3.0 were conducted according to the test setup and parameters established in Section 5.2.3. Table B 30 presents the results observed in the ATSC 3.0 demodulator.

Table B 30 - ATSC 3.0 interference with its own system

ATSC 3.0 Interference Co-channel		Config 1	Config 2	
		QPSK	CL QPSK	EL 16QAM
CH33	CH31	- 53.6	- 53.4	- 62.9
	CH32	- 42.2	- 42.2	- 54.9
	CH34	- 42.1	- 42.1	- 55.5
	CH35	- 53.7	- 53.9	- 64.9

### 6.3.2.1.2.7 Co-Channel and Adjacent channel interference (at $N\pm 1$ and $N\pm 2$ channels) of the ISDB-T to ATSC 3.0

The tests of co-channel and adjacent channel interference of ISDB-T system to ATSC 3.0 were conducted according to the test setup and parameters established in Section 5.2.4. Table B 31 presents the results of the tests for the ISDB-T interfering signal with ATSC 3.0 RF input.

Table B 31 - Results of co-channel and adjacent channel interference of ISDB-T to ATSC 3.0

Desired Channel	Interferer Channel	Protection Ratio D/U (dB)	
		D = Config 2	
		U = ISDB-T	
		CL	EL
CH33	CH31	- 53.8	- 44.2
	CH32	- 42.2	- 36.2
	CH33	- 1.8	14.7
	CH34	- 42.0	- 36.7
	CH35	- 54.2	- 47.7

### 6.3.2.1.2.8 Impulse Noise

The tests of interference of impulse noise were conducted according to the test setup and the procedures established in Section 5.2.5.

The ATSC 3.0 tests were performed on UHF only since the exciters provided for the tests do not operate in VHF. The impulse noise power level of the test setup allowed a maximum C/Neq of - 38.8 dB in the channel 33.

Results are presented in Table B 32, where the ATSC 3.0 system did not reach TOV with the maximum interference level. The result is set as better than - 38.8 dB (< - 38.8 dB).

**Table B 32 - Impulse Noise interference test results (C = - 63 dBm)**

Noise Type	Config 1	Config 2	
	C/Neq (dB)	C/Neq (dB)	
	CH30	CH30	
	CL	CL	EL
N1	< - 38.7	< - 37.7	< - 37.7
N2	< - 38.7	< - 37.7	< - 37.7
N3	< - 38.7	< - 37.7	< - 37.7
N4	< - 38.7	< - 37.7	< - 37.7
N5	< - 38.7	< - 37.7	< - 37.7
N6	< - 38.7	< - 37.7	< - 37.7
N7	< - 38.7	< - 37.7	< - 37.7
N8 (1 μs)	< - 38.7	< - 37.7	< - 37.7
N8 (10 μs)	< - 38.7	< - 37.7	< - 37.7
N8 (20 μs)	< - 38.7	< - 37.7	< - 37.7
N8 (30 μs)	< - 38.7	< - 37.7	- 20.0
N8 (40 μs)	< - 38.7	< - 37.7	- 17.6
N8 (70 μs)	< - 38.7	< - 37.7	- 16.4
N8 (80 μs)	< - 38.7	< - 37.7	- 14.5
N8 (90 μs)	< - 38.7	< - 37.7	- 14.5
N8 (100 μs)	< - 38.7	< - 37.7	- 14.1
N8 (150 μs)	< - 38.7	< - 37.7	- 13.7
N8 (200 μs)	< - 38.7	< - 37.7	- 11.9
N8 (250 μs)	< - 38.7	< - 37.7	- 10.8
N8 (300 μs)	< - 38.7	< - 37.7	- 9.7
N8 (350 μs)	- 17.8	< - 37.7	- 8.9
N8 (400 μs)	- 16.6	< - 37.7	- 8.3
N8 (450 μs)	- 15.4	- 31.7	- 7.8
N8 (500 μs)	- 14.5	- 23.4	- 7.3
N8 (600 μs)	- 13.3	- 23.0	- 6.8
N8 (700 μs)	- 12.2	- 21.7	- 6.0
N8 (800 μs)	- 11.5	- 21.0	- 5.5
N8 (900 μs)	- 11.1	- 20.9	- 4.9

### 6.3.2.1.2.9 Single Echo Static Multipath Interference

The tests of single echo static multipath interference were conducted according to the test setup and procedures established in Section 5.2.6. The results for channel 33 are presented in Table B 33 and Table B 34.

**Table B 33 - Single echo static multipath interference for Single Layer**

Pre-Echo – Config 1		Post-Echo – Config 1	
Delay (μs)	CL Echo Att (dB)	Delay (μs)	CL Echo Att (dB)
1	0	1	0
10	0	10	0
50	0	50	0
100	0	100	0
111	0	111	0
113.4	0	113.4	0
122.1	0	122.1	0
126	0	126	0
138.6	0	138.6	0
150	0.5	150	0.5
200	0	200	0
250	2.2	250	2.2
300	2.1	300	2.1

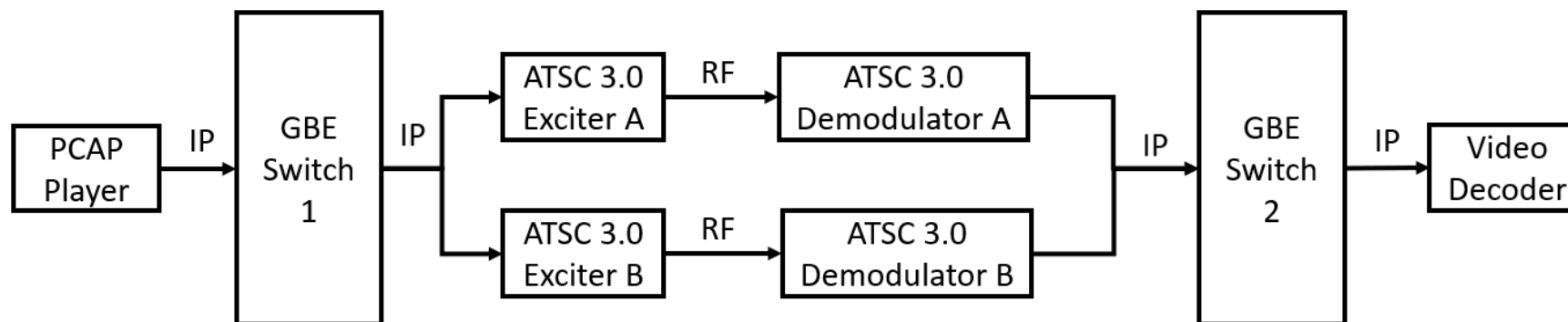


**Table B 34 - Single echo static multipath interference for Dual Layer**

Pre-Echo – Config 2			Post-Echo – Config 2		
Delay (µs)	CL Echo Att (dB)	EL Echo Att (dB)	Delay (µs)	CL Echo Att (dB)	EL Echo Att (dB)
1	0	0	1	0	0
10	0	15.4	10	23.2	24.2
50	1.9	14.4	50	1.9	14.4
100	0	14.4	100	0	14.4
111	0	14.4	111	0	14.4
113.4	0	14.4	113.4	0	14.4
122.1	0	14.4	122.1	0	14.4
126	0	14.4	126	0	14.4
138.6	0	16.3	138.6	0	16.3
150	3	16.3	150	1.3	16.3
200	1	14.4	200	1.1	14.4
250	2.9	14.4	250	2.9	14.4
300	2.9	17.3	300	2.9	17.3

### 6.3.2.1.2.10 Channel Bonding

The Channel Bonding verification follows the test procedure described in Section 4.2.3.2.8 of the Phase 2 document. The equipment provided by the proponent has the Channel Bonding capability, combining the same information in more than one channel, enhancing reliability and data throughput. It is implemented with the same transmission CH30 and CH36, operating simultaneously, with the proper channel bonding software used along the chain. The basic test setup is shown in Figure B 10.



**Figure B 10 - Channel Bonding setup TOV measurement**

The PCAP Player generates up to four multicast UDP streams that are used to configure the Core Layer and Enhanced Layer for ATSC 3.0 Exciters A and B. After the RF transmission, the ATSC 3.0 Demodulators forward the recovered multicast UDP streams to the Decoder PC. The TOV measurement is conducted using the Video Decoder.

The tests were conducted in channels 30 and 36 in the combination shown in Table B 35 and Table B 36. The measurements observed audio and video for three minutes.

**Table B 35 - Channel Bonding – Single Layer**

CH	Config	Bit Rate per channel (Mbps)	Total Bit Rate (Mbps)	QEF Criteria	Result	
					CL	EL
30	1	4.00	8.00	TOV	Pass	
36	1	4.00	8.00			

**Table B 36 - Channel Bonding – Dual Layer**

CH	Config	Bit Rate per channel (Mbps)	Total Bit Rate (Mbps)	QEF Criteria	Result	
					CL	EL
30	2	CL = 4.00 EL = 20.1	CL = 8.00 EL = 40.2	TOV	Pass	Pass
36	2	CL = 4.00 EL = 20.1	CL = 8.00 EL = 40.2			

**6.3.2.1.2.11 Channel Identification Stability in Frequency Reuse-1 condition**

The Channel Identification Stability in Frequency Reuse-1 condition verification follows the test procedure described in Section 4.2.3.2.9 of the Phase 2 document. This test aims to ensure the stability of the frequency reuse-1 for a duration of 1 hour and measure the desired channel. Table B 37 and Table B 38 show the results of the frequency reuse-1 verification.

**Table B 37 - Frequency Reuse-1 condition for Single Layer**

CH	U Frequency Offset (Hz)	U Pilot Pattern	TX Sync	D = Config 1 U = Config 1	D = Config 3 U = Config 3
				CL D/U = 0 dB	CL D/U = 0 dB
33	0	8_2	On	Pass	Pass

**Table B 38 - Frequency Reuse-1 condition for Dual Layer**

CH	U Frequency Offset (Hz)	U Pilot Pattern	TX Sync	D = Config 5 U = Config 5		D = Config 2 U = Config 2	
				CL D/U = 0 dB	EL D/U = 16 dB <sup>5</sup>	CL D/U = 0dB	EL D/U = 16dB <sup>5</sup>
33	0	8_2	On	Pass	Pass	Pass	Pass

<sup>5</sup> D/U = 16 dB following reference antenna directivity.

**6.3.2.1.3 Summary of Tests Results****Table B 39 - Summary of Test Results - Candidate B**

use case		minimum technical specification		fulfillment	
PL1	Enable side-by-side operation with existing ISDB-T systems in the same frequency bands, with minimum impact over existing network planning.	PL1.1.1	frequency band	174-216 MHz	not verified
		PL1.1.2		174-230 MHz	not verified
		PL1.1.3		470-698 MHz	fulfilled
		PL1.1.4		other frequency bands	not verified
		PL1.2.1	channel bandwidth	6 MHz	fulfilled
		PL1.2.2		7 MHz	not verified
		PL1.2.3		8 MHz	not verified
		PL1.2.4		other channel bandwidths	not verified
		PL1.3	co-channel PR (wanted: ISDB-T / unwanted: TV 3.0)	≤ 19 dB	fulfilled <sup>6</sup>
		PL1.4	adjacent-channel PR (wanted: ISDB-T / unwanted: TV 3.0)	≤ -36 dB	fulfilled <sup>6</sup>

---

<sup>6</sup> Tested only using channel 30 (UHF).

use case		minimum technical specification			fulfillment
PL2	Enable scalable broadcast network deployment (in terms of coverage and capacity), flexible frequency reuse with spatial content segmentation (reuse-1), and the most efficient spectrum use possible, targeting both fixed indoor and mobile (high-speed) outdoor reception.	PL2.1	MIMO	2x2	fulfilled
		PL2.2	multi-RF channel transmission	channel bonding - content is spread over two or more RF channels	fulfilled
		PL2.3	high-speed reception	120 Km/h	partially fulfilled
		PL2.4	spectrum efficiency	bit/s/Hz @ C/N ≤ 0 dB in Rayleigh channel	0.88 bit/s/Hz 5.3 Mbps / 6 MHz (MIMO, single layer) @ C/N ≤ 0 dB <sup>7</sup> .  4.0 bit/s/Hz 5.3+18.8 Mbps / 6 MHz (MIMO, dual-layer) @ C/N ≤ 0 dB for main layer and C/N ≤ 16dB for secondary layer <sup>7</sup> .
PL3	Provide "wake-up" capability for compatible receivers in case of an emergency warning.	PL3.1	"wake-up" capability		not verified
PL4	Enable future extensions to the physical layer (e.g., to support new modulation schemes).	PL4.1	extensibility		not verified

## 6.4 Candidate Technology C

5G Broadcast is one of the candidate technologies submitted for evaluation to the TV 3.0 System. It was developed and specified as part of the general mobile communication technology of 3GPP, which was initially devised to enable Media content broadcasting distribution to mobile devices and, in subsequent releases, defined in a wider scope, including TV sets.

<sup>7</sup> Configuration 3 was used for single layer and configuration 5 for dual layer.

### 6.4.1 Documentation Analysis

The proposed technology is fully standardized by an official Standardization Organization (3GPP/ETSI), so that the proponent listed and provided the links for downloading the official standards. Nonetheless, many of the documents in the list provided information regarding all layers of the system. Then, in communication with the proponent, it was agreed to consider a set of documents that contains information related to the Physical Layer. The documents agreed are listed below:

- 3GPP TS 36.101 version 16.10.0 Release 16 - Evolved Universal Terrestrial Radio Access (E-UTRA); User Equipment (UE) radio transmission and reception
- 3GPP TS 36.104 version 16.11.0 Release 16 - Evolved Universal Terrestrial Radio Access (E-UTRA); Base Station (BS) radio transmission and reception
- 3GPP TS 36.211 version 16.6.0 Release 16 - Evolved Universal Terrestrial Radio Access (E-UTRA); Physical channels and modulation
- 3GPP TS 36.212 version 16.6.0 Release 16 - Evolved Universal Terrestrial Radio Access (E-UTRA); Multiplexing and channel coding
- SBDTV Tech Requirements VS 3GPP TS.docx – document prepared and provided by the proponent

Additionally, the Test Laboratory, considered the following extra documents emitted by ETSI/3GPP and Forum paper, not previously agreed with the proponent, for the Documentation Analysis purpose:

- ETSI TS 103 720 V1.1.1 (2020-12) - 5G Broadcast System for linear TV and radio services; LTE-based 5G terrestrial broadcast system
- 3GPP TS 36.213 version 16.7.1 Release 16 - Evolved Universal Terrestrial Radio Access (E-UTRA); Physical layer procedures
- 3GPP TS 22.146 version 16.0.0 Release 16 - Multimedia Broadcast/Multicast Service (MBMS); Stage 1
- 3GPP TS 22.246 version 16.0.0 Release 16 - Multimedia Broadcast/Multicast Service (MBMS) user services; Stage 1
- 5G Broadcast Solution - FuTURE Forum 5G Broadcast and Video WG - 2020/11/27

Besides the above document, Instruction Manuals of the equipment delivered to the Test Lab, as well as a series of papers concerning digital broadcasting, were submitted but are not listed here. Also, many meetings between Test Lab and proponent were convened, during the test period, on almost a weekly basis.

The implementation of the UE device is limited to Release 12, which turns the system evaluation limited.

### 6.4.2 Test Results

Table C 1 shows the list of equipment received by the test laboratory, which were sent by the proponent.

**Table C 1 - List of equipment provided by 5G Broadcast consortium**

Equipment	Quantity
TCE901 Exciter	4
8 Port Switch	1
Server Switch	1
BSCC	1
Qualcomm Reference Design Mobile unit	2
GPS Antenna	1
SDE900	4
Cabling	1
Notebook with R&S Romes app	1

Due to a limitation on the QUALCOMM receiver (UE), all the tests are conducted within 10 MHz channel bandwidth and considering 60% of time slots to meet a realistic bitrate when/if working within a 6 MHz channel. This is slightly different from Phase 2, where a 5 MHz channel was considered. Phase 2 also used release 14/16 of the standard, reaching 200 us cyclic prefix and with carrier spacing of 1.25 KHz. To provide a MIMO support, the proponent has decided to submit system in its release 12 with 15 kHz carrier spacing and 16.7 us cyclic prefix.

Another limitation is the central frequency, strictly set to operation at 622 MHz and 632 MHz.

Amongst many possible configurations that the 5G system may operate, it was previously agreed with the proponent the adoption of the modulation/codification parameters of Table C 2, reaching the transmission of 1080p signal over a channel of C/N  $\leq$  0 dB and considering a second layer with C/N better than 16 dB.

As the system is prepared to work in MIMO with 2 individual transmitters, Table C 3 shows the recommended decorrelation delay set to each transmitter to achieve a diversity gain to the system. TX3 and TX4 are used as undesired channel for D/U and Frequency reuse tests.

**Table C 2 – Main configuration for 5G Broadcasting Evaluation**

Parameter	Config 1	Config 2	Config 3		Config 4		Config 5	
			MCH1	MCH2	MCH1	MCH2	MCH1	MCH2
<b>Bandwidth (ch/occ) (MHz)</b>	10/9	10/9	10/9	10/9	10/9	10/9	10/9	10/9
<b>Cyclic Prefix (us)</b>	16.7	16.7	16.7	16.7	16.7	16.7	16.7	16.7
<b>Sub-Carriers for 15 kHz carrier spacing</b>	601	601	601	601	601	601	601	601
<b>MCS</b>	MCS4	MCS5	MSC4	MCS16	MSC5	MSC22	MSC2	MSC22
<b>Modulation</b>	QPSK	QPSK	QPSK	16QAM	QPSK	64QAM	QPSK	64QAM
<b>Turbo Code Rate</b>	0.285	0.351	0.285	0.612	0.351	0.604	0.097	0.604
<b>sfAllocEnd</b>	191	191	100	91 (191)	100	91 (191)	100	91 (191)
<b>Signaling</b>	MCS2	MCS2	MCS2	MCS2	MCS2	MCS2	MCS2	MCS2
<b>Bit Rate (Mbps)</b>	2.1587	2.614	1.128	4.299	1.366	6.453	0.692	6.453

Table C 3 – MIMO Setup

MIMO Configuration		SFN Delay (us)
Desired	TX1 H1	0
	TX2 V1	3
Undesired	TX3 H2	0/2
	TX4 V2	3/5

### 6.4.2.1 Laboratory Tests

The Laboratory Tests are conducted inside a Faraday Cage, to avoid external interferences of TV, Radio, Wi-Fi, and other undesired RF sources, and under controlled temperature and humidity as specified in ABNT NBR 15604 standard.

#### 6.4.2.1.1 Device Verification Tests

The Device Verification tests are performed with the intention to verify the basic characteristics of the sample Exciter device itself, to give assurance of no significant interference, during the on-site field evaluation tests, on the other TV channels already in operation, and have no intention to be an evaluation item of the candidate TV 3.0 system.

The 5G System under evaluation has a limited frequency range (617 MHz to 637 MHz) and are being tested with a 10 MHz bandwidth, since receiver (UE) is not deployed with 6 MHz as per the Brazilian VHF and UHF channels. Due to that, part of the verification tests will not be performed.

##### 6.4.2.1.1.1 RF frequency accuracy (precision)

The RF frequency accuracy was measured, following the procedure established in Section 5.1.1, at the output of the Exciter submitted by the proponent, which was configured to output a CW signal. The measurements are done using external reference (Master Clock) and each equipment has one single RF output (one polarization). The results are presented in Table C 4 for the exciter A to D. It is worth emphasizing that, two exciters output are used to emulate a MIMO system.



**Table C 4 - RF Frequency Accuracy**

Channel	Nominal RF Frequency (Hz)	Exciter	Deviation (Hz)	Deviation (ppm)
622 MHz	622.000000E+06	A	- 0.090	0.0001
		B	0.070	0.0001
		C	- 0.040	0.0001
		D	0.000	0.0000

#### 6.4.2.1.1.2 Phase noise of local oscillators

The RF Phase Noise was measured, following the procedure established in Section 4.2.3.1.2 of the “TV 3.0 CfP Phase 2 / Testing and Evaluation” document, at the output of the exciter submitted by the proponent, which was configured to output a CW signal. The measurements are done using external reference (Master Clock) and presented in the Table C 5.

**Table C 5 - RF Phase Noise**

Exciter	Polarization	Integral (100 Hz – 10 MHz) dBc
		622 MHz
A	H1	- 45.4
B	V1	- 41.4
C	H2	- 56.0
D	V2	- 56.1

#### 6.4.2.1.1.3 RF signal power

The RF/IF signal power was measured, following the procedure established in Section 4.2.3.1.3 of the “TV 3.0 CfP Phase 2 / Testing and Evaluation” document, at the output of the exciter submitted by the proponent. Exciter was configured to output a CW signal. The measurements are done using external reference (Master Clock) and are presented in the Table C 6.

Table C 6 - RF Signal Power

Channel	Nominal RF Frequency	Exciter	Polarization	Measured Power (dBm)
617- 627 MHz	622.000000E+06	A	H1	8.78
		B	V1	9.16
		C	H2	7.08
		D	V2	7.8

#### 6.4.2.1.1.4 RF out of band emissions and linearity characterization (Spectrum Mask)

The proponent informed that the emission mask to be adopted is defined in document 3GPP TS 36.101 version 16.10.0 Release 16, shown in Section 6.4.1. The emission mask is shown in Figure C 1.

**Table 6.6.2.1.1-1: General E-UTRA spectrum emission mask**

$\Delta f_{00B}$ (MHz)	Spectrum emission limit (dBm)/ channel bandwidth						Measurement bandwidth
	1.4 MHz	3.0 MHz	5 MHz	10 MHz	15 MHz	20 MHz	
± 0-1	-10	-13	-15	-18	-20	-21	30 kHz
± 1-2.5	-10	-10	-10	-10	-10	-10	1 MHz
± 2.5-2.8	-25	-10	-10	-10	-10	-10	1 MHz
± 2.8-5		-10	-10	-10	-10	-10	1 MHz
± 5-6		-25	-13	-13	-13	-13	1 MHz
± 6-10			-25	-13	-13	-13	1 MHz
± 10-15				-25	-13	-13	1 MHz
± 15-20					-25	-13	1 MHz
± 20-25						-25	1 MHz

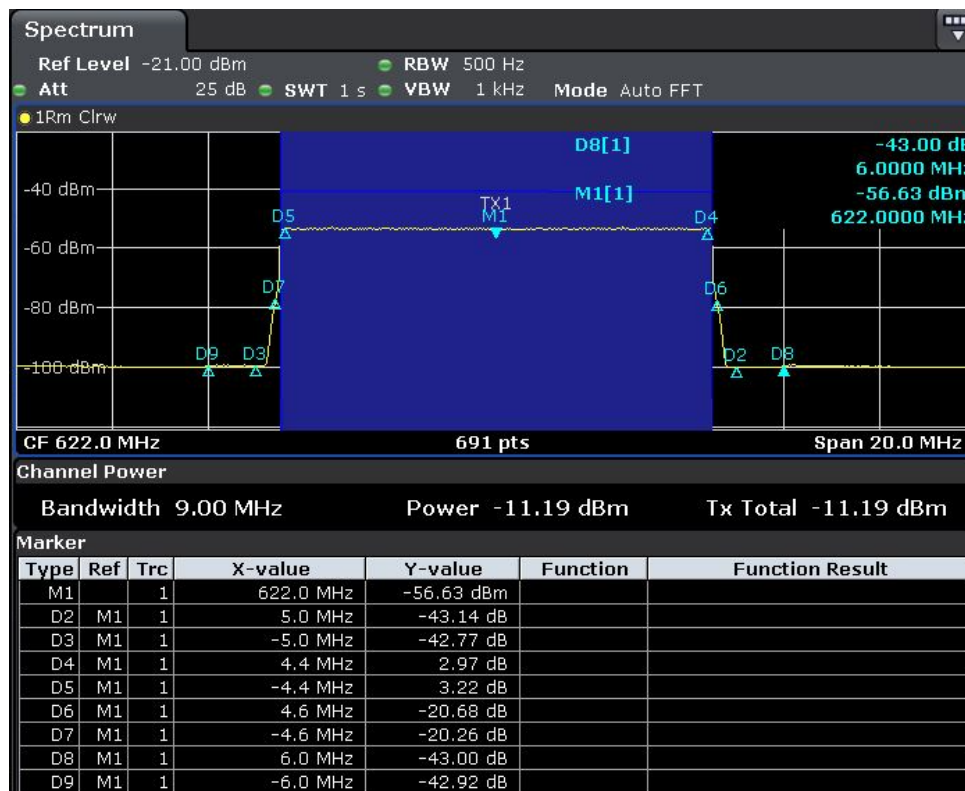
**Table 6.6.4.1.2.1-1: BS Spurious emissions limits, Category B**

Frequency range	Maximum Level	Measurement Bandwidth	Note
9 kHz ↔ 150 kHz	-36 dBm	1 kHz	Note 1
150 kHz ↔ 30 MHz	-36 dBm	10 kHz	Note 1
30 MHz ↔ 1 GHz	-36 dBm	100 kHz	Note 1
1 GHz ↔ 12.75 GHz	-30 dBm	1 MHz	Note 2
12.75 GHz ↔ 5 <sup>th</sup> harmonic of the upper frequency edge of the DL operating band in GHz	-30 dBm	1 MHz	Note 2, Note 3
12.75 GHz ↔ 26 GHz	-30 dBm	1 MHz	Note 2, Note 4

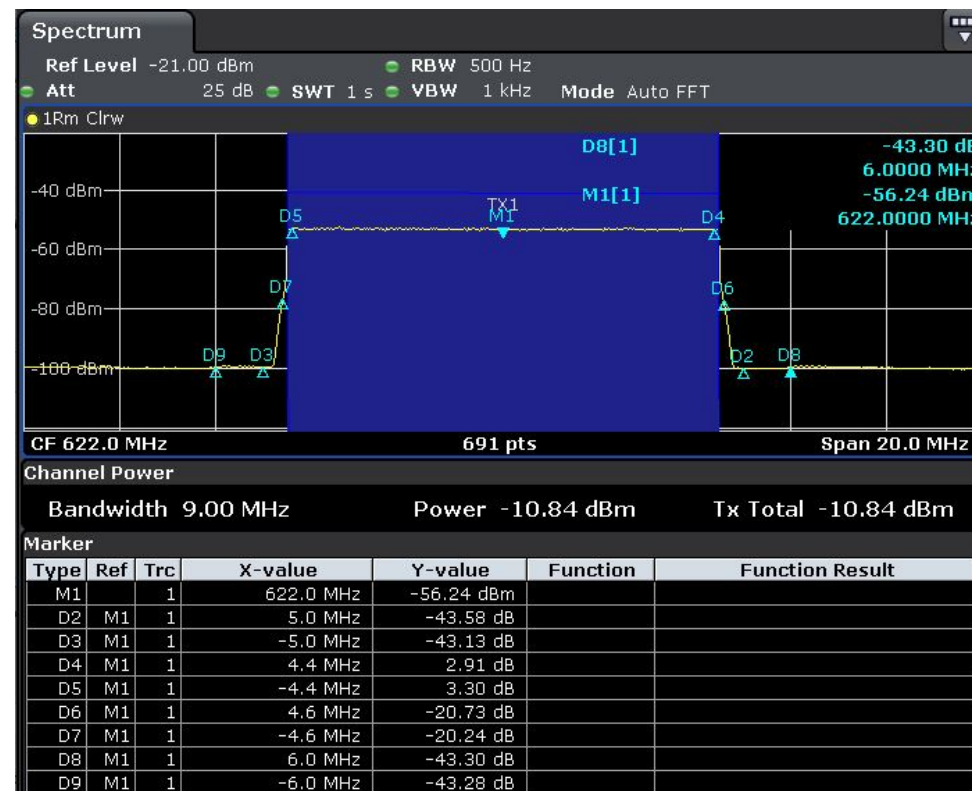
NOTE 1: Bandwidth as in ITU-R SM.329 [2], s4.1  
 NOTE 2: Bandwidth as in ITU-R SM.329 [2], s4.1. Upper frequency as in ITU-R SM.329 [2], s2.5 table 1  
 NOTE 3: Applies only for Bands 22, 42, 43, 48 and 49.  
 NOTE 4: Applies only for Band 46.

**Figure C 1 - Emission mask specification for 5G**

The RF/IF spectrum mask was measured, following the procedure established in Section 4.2.3.1.4 of the “TV 3.0 CfP Phase 2 / Testing and Evaluation” document, at the output of the exciter submitted by the proponent. The spectrum mask in all the exciters was analyzed for the Config 1 only and results are presented on Figure C 2 and Table C 7 for Exciters A and B and on Figure C 3 and Table C 8 the results for Exciters C and D.



(a)



(b)

Figure C 2 - Spectrum Mask of Exciter A (a) Horizontal Polarization, and Exciter B (b) Vertical Polarization

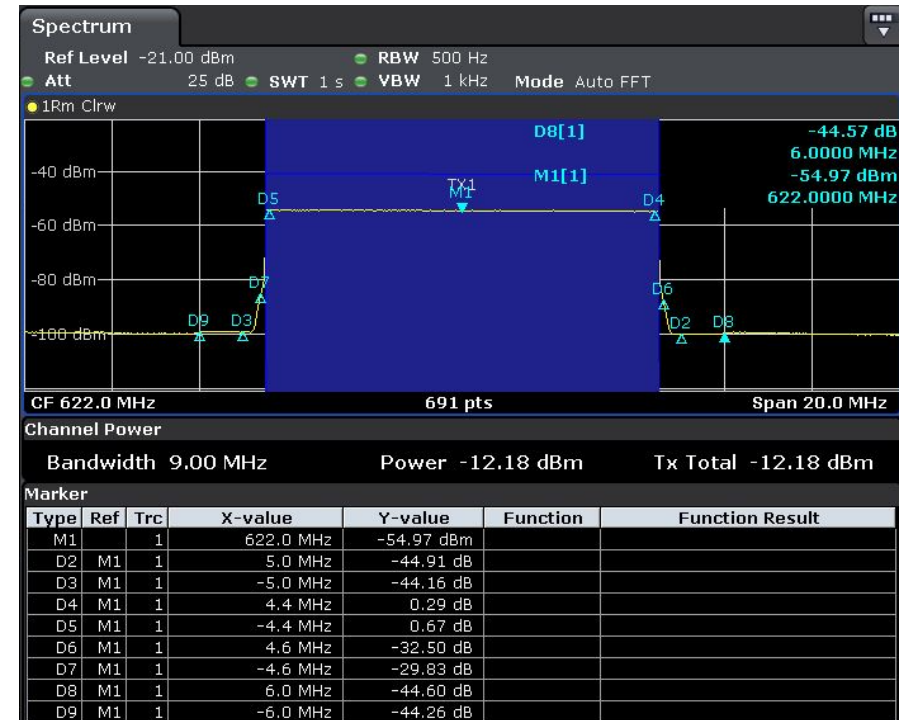
Table C 7 shows the mask result compared to the 5G Broadcast Mask recommendation for Exciters A and B.

**Table C 7 - MASK for Config 1 - Exciter A (H) and Exciter B (V)**

<b>M1 = 622 MHz</b>		<b>Horizontal</b>		<b>Vertical</b>	
<b>Marker Name</b>	<b>Delta Frequency (MHz)</b>	<b>Delta Value (dB)</b>	<b>Result</b>	<b>Delta Value (dB)</b>	<b>Result</b>
D2	M1 - 4.4	3.22	OK	3.30	OK
D3	M1 + 4.4	2.97	OK	2.91	OK
D4	M1 - 4.6	-20.26	OK	-20.24	OK
D5	M1 + 4.6	-20.68	OK	-20.73	OK
D6	M1 - 5	-42.77	OK	-43.13	OK
D7	M1 + 5	-43.14	OK	-43.58	OK
D8	M1 - 6	-42.92	OK	-43.28	OK
D9	M1 + 6	-43.00	OK	-43.30	OK



(a)



(b)

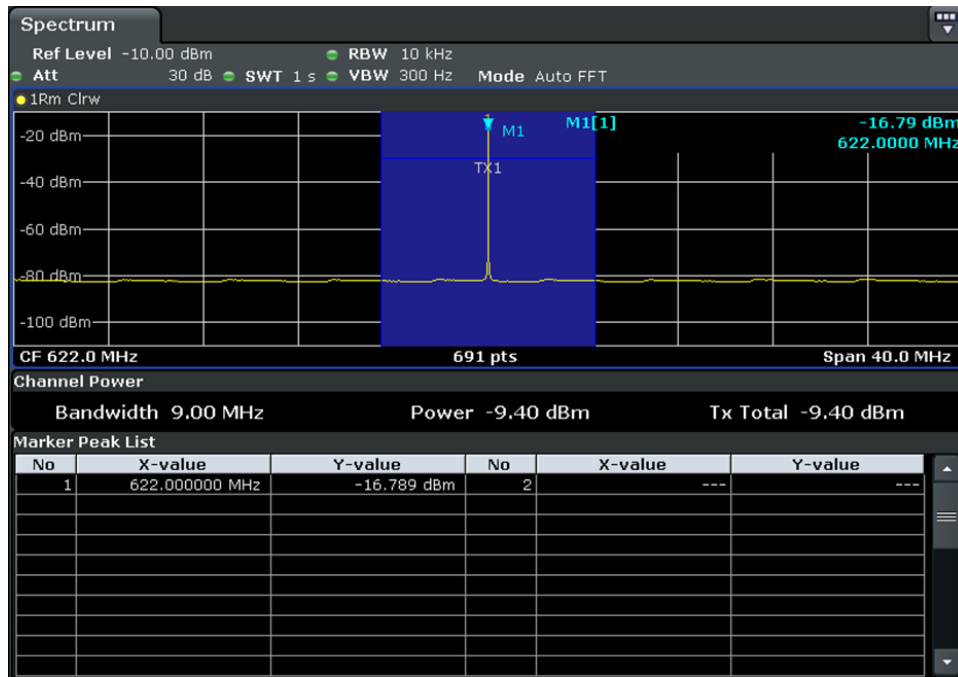
Figure C 3 - Spectrum Mask of Exciter C (a) Horizontal Polarization, and Exciter D (b) Vertical Polarization

Table C 8 shows the mask result compared to the 5G Broadcast Mask recommendation for Exciters C and D.

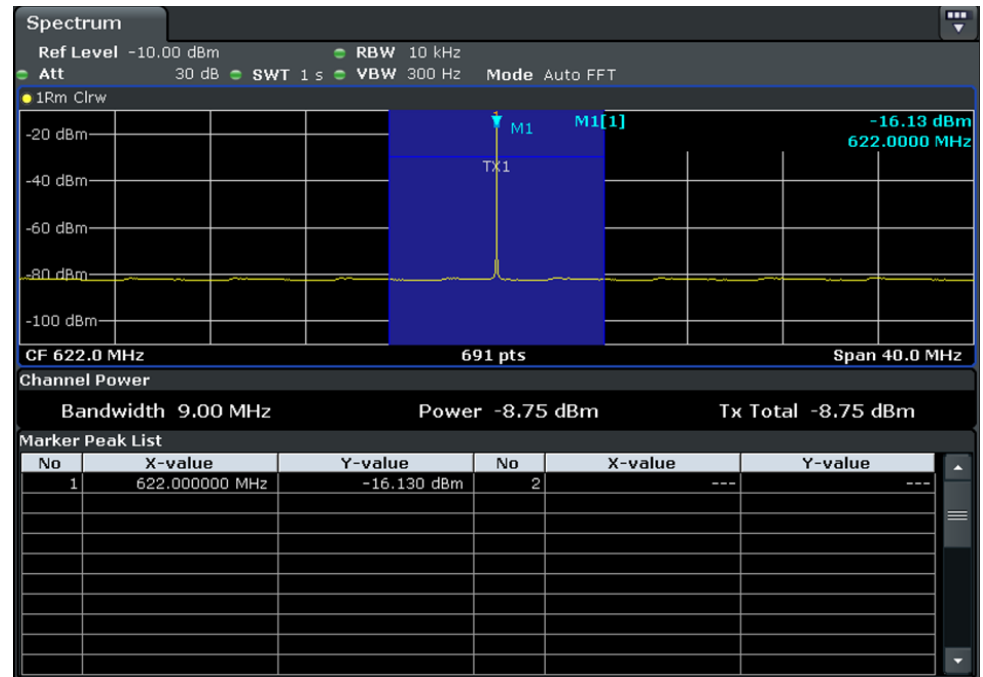
**Table C 8 - MASK for Config 1 - Exciter C (H) and Exciter D (V)**

M1 - 622 MHz		Horizontal		Vertical	
Marker Name	Delta Frequency (MHz)	Delta Value (dB)	Result	Delta Value (dB)	Result
D2	M1 - 4.4	0.64	OK	0.67	OK
D3	M1 + 4.4	0.35	OK	0.29	OK
D4	M1 - 4.6	-29.29	OK	-29.83	OK
D5	M1 + 4.6	-32.40	OK	-32.50	OK
D6	M1 - 5	-43.64	OK	-44.16	OK
D7	M1 + 5	-44.34	OK	-44.91	OK
D8	M1 - 6	-43.75	OK	-44.26	OK
D9	M1 + 6	-44.02	OK	-44.60	OK

The RF/IF Out-of-Band Emissions were measured, following the procedure established in Section 4.2.3.1.4 of the “TV 3.0 CfP Phase 2 / Testing and Evaluation” document, at the output of the exciters submitted by the proponent. The exciters were configured to output a CW signal. The results for Exciters A and B are presented in Figure C 4 and for Exciters C and D in Figure C 5.



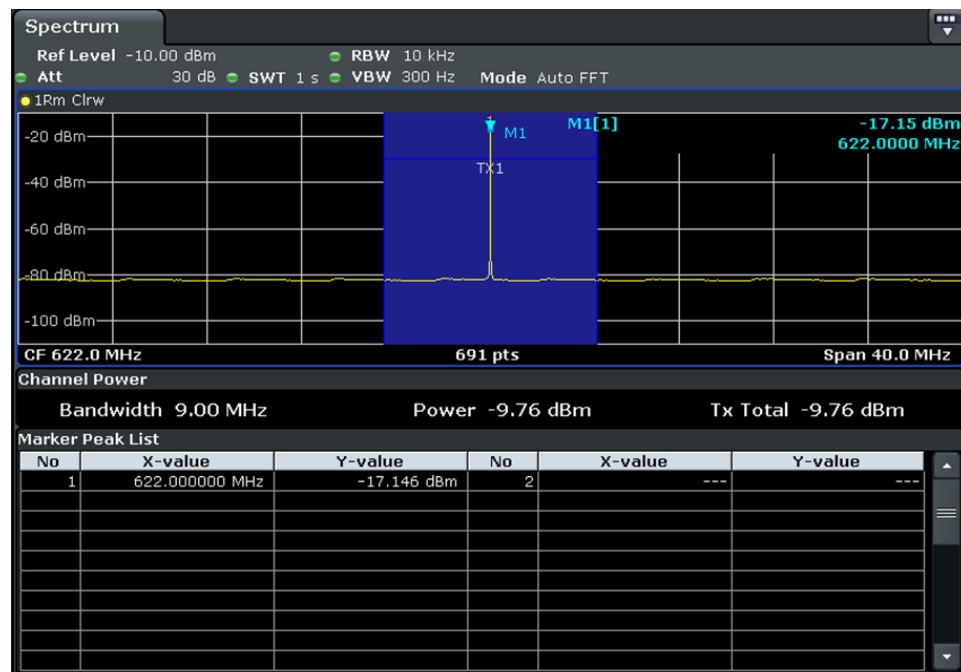
(a)



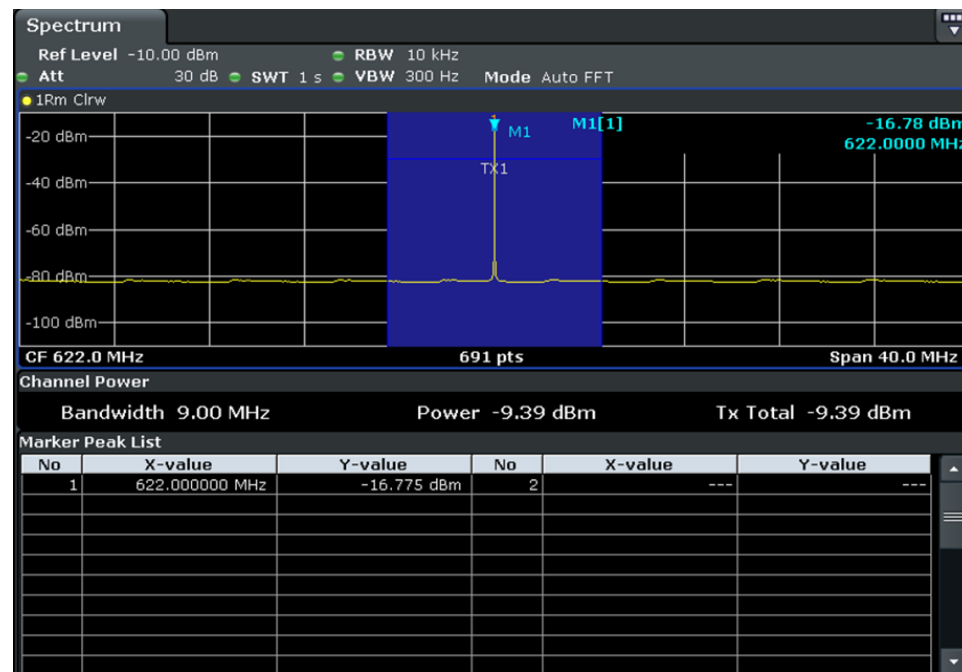
(b)

Figure C 4 - 622 MHz carrier Out-of-Band Emissions of Exciter A (a) Horizontal Polarization, and Exciter B (b) Vertical Polarization





(a)



(b)

Figure C 5 - 622 MHz carrier Out-of-Band Emissions of Exciter C (a) Horizontal Polarization, and Exciter D (b) Vertical Polarization

#### 6.4.2.1.1.5 I/Q analysis – Constellation and MER

The proponent did not send any instrument capable of displaying the constellation and measuring the MER.

#### 6.4.2.1.2 Evaluation Tests

Even though the reception equipment did not allow a Constellation and MER analysis, the verifications tests results guarantee the necessary conditions to proceed with the Evaluation Tests. The system provided by the proponent is restricted to Release 12 of the 5G Broadcasting Standard and is limited to 15 kHz sub-carrier spacing and 16.7 us Cyclic Prefix. All tests are conducted in MIMO configuration.

#### 6.4.2.1.2.1 C/N - Carrier power vs AWGN

The C/N tests over AWGN channel results are present below and follow the test procedure described in Section 4.2.3.2.1 of the Phase 2 document and the results are presented in Table C 9 and Table C 10. Due to the instability of the equipment sent by the proponent, the tests with C = - 68 dBm and - 83 dBm could not be carried out.

Table C 9 - C/N over AWGN for Single Layer

CH	Config 1		Config 2	
	C/N (dB)		C/N (dB)	
	C = - 28 dBm	C = - 53 dBm	C = - 28 dBm	C = - 53 dBm
622 MHz	- 2.4	- 2.4	- 1.4	- 1.4

Table C 10 - C/N over AWGN for Dual Layer

CH	Config 3				Config 4			
	C/N (dB)				C/N (dB)			
	C = - 28 dBm		C = - 53 dBm		C = - 28 dBm		C = - 53 dBm	
	MCH1	MCH2	MCH1	MCH2	MCH1	MCH2	MCH1	MCH2
622 MHz	- 2.0	7.9	- 2.1	7.7	- 1.4	14.1	- 1.4	14.8

#### 6.4.2.1.2.2 C/N - Carrier power vs Noise Power over Rayleigh and AWGN Channels

The C/N over Rayleigh and AWGN channel was conducted according to Section 5.2.1, including the fading parameters. The results are presented in Table C 11 to Table C 22. Due to the instability of the equipment sent by the proponent, the tests with C = - 68 dBm and - 83 dBm could not be carried out.

Table C 11 - C/N over Rayleigh Ensemble RF1 for Single Layer

CH (622 MHz)	Results			
	C/N (dB)			
	C = - 28 dBm		C = - 53 dBm	
Speed (Km/h)	0	3	0	3
Config 1	- 2.2	Not Tested	- 2.4	Not Tested
Config 2	- 1.3	Not Tested	- 1.3	Not Tested

**Table C 12 - C/N over Rayleigh Ensemble RF1 for Dual Layer**

CH (622 MHz)	Results							
	C/N (dB)							
	C = - 28 dBm				C = - 53 dBm			
	MCH1		MCH2		MCH1		MCH2	
Speed (Km/h)	0	3	0	3	0	3	0	3
Config 4	- 2.21	Not Tested	13.3	Not Tested	- 2.2	Not Tested	13.2	Not Tested

**Table C 13 - C/N over Rayleigh Ensemble RF2A for Single Layer**

CH (622 MHz)	Results			
	C/N (dB)			
	C = - 28 dBm		C = - 53 dBm	
Speed (Km/h)	0	3	0	3
Config 1	- 2.0	Not Tested	- 2.2	Not Tested
Config 2	- 2.2	Not Tested	- 2.1	Not Tested

**Table C 14 - C/N over Rayleigh Ensemble RF2A for Dual Layer**

CH (622 MHz)	Results							
	C/N (dB)							
	C = - 28 dBm				C = - 53 dBm			
	MCH1		MCH2		MCH1		MCH2	
Speed (Km/h)	0	3	0	3	0	3	0	3
Config 4	- 2	Not Tested	13.3	Not Tested	- 2	Not Tested	13.3	Not Tested

**Table C 15 - C/N over Rayleigh Ensemble RF2B for Single Layer**

CH (622 MHz)	Results			
	C/N (dB)			
	C = - 28 dBm		C = - 53 dBm	
Speed (Km/h)	0	3	0	3
Config 1	- 1.4	Not Tested	- 0.6	Not Tested
Config 2	- 0.3	Not Tested	- 0.3	Not Tested

**Table C 16 - C/N over Rayleigh Ensemble RF2B for Dual Layer**

CH (622 MHz)	Results							
	C/N (dB)							
	C = - 28 dBm				C = - 53 dBm			
	MCH1		MCH2		MCH1		MCH2	
Speed (Km/h)	0	3	0	3	0	3	0	3
Config 4	- 0.4	Not Tested	15.8	Not Tested	- 0.2	Not Tested	15.9	Not Tested

**Table C 17 - C/N over Rayleigh Ensemble RF3A for Single Layer**

CH (622 MHz)	Results					
	C/N (dB)					
	C = - 28 dBm			C = - 53 dBm		
	0	50	120	0	50	120
Speed (Km/h)	0	50	120	0	50	120
Config 1	- 0.1	Not Tested	Not Tested	- 1.1	Not Tested	Not Tested
Config 2	1.2	Not Tested	Not Tested	1.3	Not Tested	Not Tested

**Table C 18 - C/N over Rayleigh Ensemble RF3A for Dual Layer**

CH (622 MHz)	Results											
	C/N (dB)											
	C = - 28 dBm						C = - 53 dBm					
	MCH1			MCH2			MCH1			MCH2		
Speed (Km/h)	0	50	120	0	50	120	0	50	120	0	50	120
Config 4	1.1	Not Tested	Not Tested	16.7	Not Tested	Not Tested	0.9	Not Tested	Not Tested	17	Not Tested	Not Tested

**Table C 19 - C/N over Rayleigh Ensemble RF3B for Single Layer**

CH (622 MHz)	Results					
	C/N (dB)					
	C = - 28 dBm			C = - 53 dBm		
	0	50	120	0	50	120
Speed (Km/h)	0	50	120	0	50	120
Config 1	- 1.1	Not Tested	Not Tested	- 1.8	Not Tested	Not Tested
Config 2	1.1	Not Tested	Not Tested	0.9	Not Tested	Not Tested

Table C 20 - C/N over Rayleigh Ensemble RF3B for Dual Layer

CH (622 MHz)	Results											
	C/N (dB)											
	C = - 28 dBm						C = - 53 dBm					
	MCH1			MCH2			MCH1			MCH2		
Speed (Km/h)	0	50	120	0	50	120	0	50	120	0	50	120
Config 4	Failed	Not Tested	Not Tested	Failed	Not Tested	Not Tested	Failed	Not Tested	Not Tested	Failed	Not Tested	Not Tested

Table C 21 - C/N over Rayleigh Ensemble RF4 for Single Layer

CH (622 MHz)	Results					
	C/N (dB)					
	C = - 28 dBm			C = - 53 dBm		
	Speed (Km/h)	0	50	120	0	50
Config 1	- 0.2	Not Tested	Not Tested	- 1.3	Not Tested	Not Tested
Config 2	- 1.1	Not Tested	Not Tested	- 1	Not Tested	Not Tested

Table C 22 - C/N over Rayleigh Ensemble RF4 for Dual Layer

CH (622 MHz)	Results											
	C/N (dB)											
	C = - 28 dBm						C = - 53 dBm					
	MCH1			MCH2			MCH1			MCH2		
Speed (Km/h)	0	50	120	0	50	120	0	50	120	0	50	120
Config 4	- 0.8	Not Tested	Not Tested	17.5	Not Tested	Not Tested	- 0.6	Not Tested	Not Tested	17.1	Not Tested	Not Tested

#### 6.4.2.1.2.3 Receiver maximum and minimum power levels

The demodulator maximum and minimum level tests were carried out according to the established procedures described in Section 4.2.3.2.3 on the Phase 2 document, with same attenuation for the Vertical and Horizontal polarizations. Note that the maximum level was limited to the maximum power specified by the manufacturer. Tests were conducted using the frequency of 622 MHz and results are presented on Table C 23 for Single Layer and Table C 24 for Dual Layer.

**Table C 23 - Maximum and Minimum Level for Single Layer**

Channel	Config 1	
	Maximum Level (dBm) <sup>8</sup>	Minimum Level (dBm)
622 MHz	4	- 99.4

**Table C 24 - Maximum and Minimum Level for Dual Layers**

Channel	Config 4			
	Maximum Level (dBm) <sup>2</sup>		Minimum Level (dBm)	
	MCH1	MCH2	MCH1	MCH2
622 MHz	- 16.3	- 14.2	- 94.5	- 90.8

#### 6.4.2.1.2.4 Co-channel Interference with its own system

The tests for co-channel interference with its own system were conducted with the test setup established in Section 4.2.3.2.4 of the test procedure of Phase 2. The tests were conducted with synchronization between the interfering and interfered signals. The results of the tests are presented in Table C 25 for Single Layer analysis and Table C 26 for Dual Layer.

**Table C 25 - 5G Broadcast own system interference for Single Layer**

Channel	D = Config 1 U = Config 1	D = Config 2 U = Config 2
	MCH1 D/U (dB)	MCH1 D/U (dB)
622 MHz	5.9	6.7

**Table C 26 - 5G Broadcast own system interference for Dual Layer**

Channel	D = Config 3 U = Config 3		D = Config 4 U = Config 4		D = Config 5 U = Config 5	
	MCH1 D/U (dB)	MCH2 D/U (dB)	MCH1 D/U (dB)	MCH2 D/U (dB)	MCH1 D/U (dB)	MCH2 D/U (dB)
	622 MHz	5.5	15.1	6.4	20.7	3.4

<sup>8</sup> REMARK: Maximum level test was limited to the maximum power specified by the manufacturer.

#### **6.4.2.1.2.5 Co-channel and adjacent channel interference (at $N\pm 1$ and $N\pm 2$ channels) to ISDB-T**

The tests of co-channel and adjacent channel interference to ISDB-T system were not conducted according to the test setup and parameters established in Section 5.2.2, since the received 5G equipment is limited to a specific channel.

#### **6.4.2.1.2.6 Adjacent channel interference (at $N\pm 1$ and $N\pm 2$ channels) with its Own System**

The tests of co-channel and adjacent channel interference of 5G Broadcast against 5G Broadcast were not conducted according to the test setup and parameters established in Section 5.2.3, since the received 5G equipment is limited to a specific channel.

#### **6.4.2.1.2.7 Co-Channel and Adjacent channel interference (at $N\pm 1$ and $N\pm 2$ channels) of the ISDB-T to 5G Broadcast**

The tests of co-channel and adjacent channel interference of ISDB-T system to 5G Broadcast were not conducted according to the test setup and parameters established in Section 5.2.4, since the channel and bandwidth of the received 5G equipment are under evaluation.

#### **6.4.2.1.2.8 Impulsive noise**

The tests of interference of impulsive noise were conducted according to the test setup and the procedures established in Section 5.2.5. Table C 27 summarizes the test results for the single- and dual-layer cases.

The maximum impulsive noise level of the test setup limits the result to a C/Neq higher than - 45.8 dB in carrier at 622/632 MHz. If results are better than the setup limitation, it is indicated as < - 45.8 dB.

**Table C 27 - Impulse Noise interference test results (D = - 63 dBm)**

Noise Type	Config 1	Config 4	
	C/Neq (dB)	C/Neq (dB)	
	622 MHz	622 MHz	
	MCH1	MCH 1	MCH2
N1	< - 45.8	< - 45.8	< - 45.8
N2	< - 45.8	< - 45.8	< - 45.8
N3	< - 45.8	< - 45.8	< - 45.8
N4	< - 45.8	< - 45.8	< - 45.8
N5	< - 45.8	< - 45.8	< - 45.8
N6	< - 45.8	< - 45.8	< - 45.8
N7	< - 45.8	< - 45.8	< - 45.8
N8 (1 $\mu$ s)	-30.2	< - 45.8	- 10.8
N8 (10 $\mu$ s)	-30.2	< - 45.8	- 5.2
N8 (20 $\mu$ s)	-30.1	< - 45.8	0.1
N8 (30 $\mu$ s)	-30.0	< - 45.8	- 6.3
N8 (40 $\mu$ s)	-29.4	< - 45.8	1.7
N8 (50 $\mu$ s)	-28.8	< - 45.8	1.4
N8 (60 $\mu$ s)	-28.7	< - 45.8	2
N8 (70 $\mu$ s)	-28.7	< - 45.8	0.3
N8 (80 $\mu$ s)	-28.7	< - 45.8	0.4
N8 (90 $\mu$ s)	-28.7	< - 45.8	1.1
N8 (100 $\mu$ s)	-28.6	< - 45.8	2.2
N8 (150 $\mu$ s)	-26.5	< - 45.8	0.4
N8 (200 $\mu$ s)	-25.2	< - 45.8	- 0.7
N8 (250 $\mu$ s)	-24.5	- 21.8	- 0.9
N8 (300 $\mu$ s)	-23.8	- 17.2	- 1.9
N8 (350 $\mu$ s)	-22.2	- 12.2	- 2.3
N8 (400 $\mu$ s)	-21.6	- 11.2	- 2.2
N8 (450 $\mu$ s)	-20.9	- 10.9	1.8
N8 (500 $\mu$ s)	17.9	- 9.2	4.3
N8 (600 $\mu$ s)	-17.7	- 9.2	- 1.2
N8 (700 $\mu$ s)	-15.7	- 7.7	- 1.8
N8 (800 $\mu$ s)	-16.2	- 6.1	- 5.7
N8 (900 $\mu$ s)	-20.7	- 6.2	- 3.3



#### 6.4.2.1.2.9 Single echo static multipath interference

The tests of single echo static multipath interference were conducted according to the test setup and procedures established in Section 5.2.6. The results for 622 MHz are presented in the Table C 28.

Table C 28 - Single echo static multipath interference

Config 1		Config 4			
QPSK – MCS 4		QPSK - MCS5	64QAM - MCS22		
Delay (μs)	Echo Att (dB)	Delay (μs)	Echo Att (dB)	Delay (μs)	Echo att (dB)
- 50	5	- 50	9.7	- 50	16.6
- 18.37	0	- 18.37	0	- 18.37	11.2
- 16.7	Unstable	- 16.7	0	- 16.7	11.4
- 15.03	0	- 15.03	0	- 15.03	11.5
15.03	0	15.03	0	15.03	11.9
16.7	Unstable	16.7	0	16.7	11.7
18.37	0	18.37	0	18.37	11.5
50	4.1	50	8.8	50	15.8

#### 6.4.2.1.2.10 Channel bonding

The equipment provided by the proponent has no Channel Bonding capability.

#### 6.4.2.1.2.11 Channel identification stability in frequency reuse-1 condition

The Channel Identification Stability in Frequency Reuse-1 condition verification follows the test procedure described in Section 4.2.3.2.9 of the Phase 2 document. The co-channel interference result with own system test was used for U signals. The tests were conducted in the RF 622 MHz channel. Table C 29 shows the results of the frequency reuse-1 verification.

Table C 29 - Stability in frequency reuse-1

Channel	U Frequency Offset (Hz)	D = Config 1	D = Config 2	D = Config 4	
		U = Config 1	U = Config 2	U = Config 4	U = Config 4
		MCH1	MCH1	MCH1	MCH2
		D/U = 0 dB	D/U = 0 dB	D/U = 0 dB	D/U = 16dB
622 MHz	0	Failed	Failed	Failed	Failed

The implementation of the system shows to be very unstable, and the lab tests team was not able to reach a D/U with the proposed decorrelation indicated on Table C 3, with several sub systems offset values.

### 6.4.2.1.3 Summary of Test Results

Table C 30 - Summary of Test Results - Candidate C

use case		minimum technical specification		fulfillment	
PL1	Enable side-by-side operation with existing ISDB-T systems in the same frequency bands, with minimum impact over existing network planning.	PL1.1.1	frequency band	174-216 MHz	not verified
		PL1.1.2		174-230 MHz	not verified
		PL1.1.3		470-698 MHz	partially fulfilled <sup>9</sup>
		PL1.1.4		other frequency bands	not verified <sup>9</sup>
		PL1.2.1	channel bandwidth	6 MHz	not fulfilled <sup>9</sup>
		PL1.2.2		7 MHz	not fulfilled <sup>9</sup>
		PL1.2.3		8 MHz	not fulfilled <sup>9</sup>
		PL1.2.4		other channel bandwidths	fulfilled <sup>9</sup> 1.4, 3, 5, 10, 15, 20 MHz are defined in TS 36.101 Chapter 5.6.
		PL1.3		co-channel PR (wanted: ISDB-T / unwanted: TV 3.0)	≤ 19 dB
		PL1.4	adjacent-channel PR (wanted: ISDB-T / unwanted: TV 3.0)	≤ -36 dB	not verified <sup>9</sup>

<sup>9</sup> Submitted equipment was compliant with Release 12 of the standard, operating only using signal bandwidth of 10 MHz at center frequencies equal to 622 or 632 MHz.

use case		minimum technical specification			fulfillment
PL2	Enable scalable broadcast network deployment (in terms of coverage and capacity), flexible frequency reuse with spatial content segmentation (reuse-1), and the most efficient spectrum use possible, targeting both fixed indoor and mobile (high-speed) outdoor reception.	PL2.1	MIMO	2x2	fulfilled
		PL2.2	multi-RF channel transmission	channel bonding - content is spread over two or more RF channels	not fulfilled
		PL2.3	high-speed reception	120 Km/h	not verified
		PL2.4	spectrum efficiency	bit/s/Hz @ C/N ≤ 0 dB in Rayleigh channel	0.44 bit/s/Hz 2.6 Mbps / 6 Mbps (MIMO, single layer) @ C/N ≤ 0 dB <sup>10</sup> .  1.30 bit/s/Hz 1.4+6.5 Mbps / 6 MHz (MIMO, dual-layer) @ C/N ≤ 0 dB for main layer and C/N ≤ 16dB for secondary layer <sup>10</sup> .
PL3	Provide "wake-up" capability for compatible receivers in case of an emergency warning.	PL3.1	"wake-up" capability		not verified
PL4	Enable future extensions to the physical layer (e.g., to support new modulation schemes).	PL4.1	extensibility		not verified

<sup>10</sup> Configuration 2 was used for single layer and configuration 4 for dual layer.

## Appendix I. Information for Reference

### I.1 Co-channel and Adjacent Channel Interference with ISDB-T

Table I 1 presents the performance of ISDB-T STB used in the Co-channel to Adjacent Channel Interference with ISDB-T test.

**Table I 1 - Results of the co-channel and adjacent channel interference with own ISDB-T interfering signal, for reference**

Protection Ratio D/U (dB)		
Desired Channel	Interferer Channel	Receiver D/U (dB)
<b>VHF</b> (Digital CH in Test – <b>CH 10</b> )	CH8	- 48.6
	CH9	- 46.8
	CH10	16.6
	CH11	- 47.3
	CH12	- 49.3
<b>UHF</b> (Digital CH in Test – <b>CH33</b> )	CH31	- 50.9
	CH32	- 48.4
	CH33	16.4
	CH34	- 48.1
	CH35	- 50.5